



Standard GloveBox

Operating Instructions

(English – 11/04 Edtn.)

Blank Page

Operation Manual Index

For Systems with MB20 and MB200 Gas Purification Systems (including Labmaster Series) and Touch Screen (TP170 Colour) Panel

Chapter

- 1 General Information**
- 2 Transport/Site Selection/Modification**
- 3 Preparing the Connections**
- 4 Installation**
- 5 Activating/Deactivating the System**
- 6 Operation Panel TOUCH panel (TP170b)**
- 7 Purging the System**
- 8 Pressure Regulation**
- 9 Circulation Mode**
- 10 Regeneration Mode**
- 11 Solvent Filter Operation (LMF)**
- 12 Parameter and Display Patterns**
- 13 Antechamber Operation (Standard)**
- 14 Oven Antechamber**
- 15 Analysers**
- 16 Glovebox Cooling**
- 17 Freezer**
- 18 Dust Filters**
- 19 Gloves**
- 20 Maintenance and Service**
- 21 "Trouble Shooting"**
- 22 Spareparts List**

Blank Page

Contents

1.1. General Information.....2

1.2. Entries Referring to the System.....2

1.3. General Safety Notice.....3

1.4. Addresses.....3

1.1. General Information

This technical documentation is not liable to any obligations on the part of the manufacturer. The manufacturer **MBRAUN GmbH** reserves the right for technical and optical modifications as well as functional modifications on the systems or system’s components described therein. Any duplication of this documentation, even in form of excerpts, is only permitted after having obtained the manufacturer’s information and concession.

Title: Operating Instructions for **MBRAUN** – Systems
with TOUCH Screen Operation Panel (TP170b)
Edition: 2003 / See Title Page for System Type
Copyright: © 2003 MBRAUN GmbH, Dieselstraße 31, D-85748, Germany

1.2. Entries Referring to the System

This documentation is part of the system:

Designation / Type:
Serial number (s):
Person(s) in charge
of the system:

Space left for notes on system settings, instructions for maintenance etc.

.....

.....

.....

.....

.....

.....

.....

.....

.....

.....

.....

.....

.....

.....

.....

.....

.....

.....

.....

.....

.....

1.3. General Safety Notice

MBRAUN inert gas boxes are operated with inert gas, in order to ensure that the Glovebox interior chamber is able to handle substances that are sensitive to oxygen and/or moisture. If the customer works with substances injurious to health, inside one the box, then the responsibility for all relevant safety regulations in respect to handling these substances need to be considered by the customer. This also applies to the disposal of all components, which come in contact with the gas flow; the box output filter as well as the further filtering mediums and the pump oil.

If strongly poisonous or radioactive substances are to be used inside the Glovebox, then certain requirements to the overall system need to be considered. These are not contained in standard systems and must be co-ordinated before acquisition of a system with **MBRAUN**.

Note:

Furthermore the following general safety reference must be considered:

**Danger of asphyxiation
when working with high inert gas concentrations.**

Therefore the following advice is given:

Notes:

- The selected location should have a “room” volume that is significantly larger than the Glovebox interior volume.
- The location should as far as possible be ventilated, especially during a purging procedure or when opening an existing installed Glovebox.
- Before opening an installed Glovebox at least one glove should always be removed first. This is to allow a slow equalisation of the Glovebox interior atmosphere with the ambient room air.
- Before execution of service work in the Glovebox interior the operator must ensure that the interior Glovebox atmosphere is completely replaced with ambient room air.

If it is not possible to adhere to all the above recommendations the customer must report this to **MBRAUN** before acquisition of the system, since it is possible to equip the system with additional safety devices.

On request **MBRAUN** can recommend a personal measuring instrument which alerts the operator to a reduction of oxygen content in the ambient air.

1.4. Addresses

Important service addresses:

MBRAUN GmbH

Dieselstraße 31
85748 Garching
Germany

Telephone: +44 (0)89 32669-230

Fax: +44 (0)89 32669-235

E-Mail: service@mbraun.de

Internet: www.mbraun.com

Blank Page

Contents

2.1. Transport of a System2

2.2. Site Selection for a System.....2

2.3. Modification of a System2

2.1. Transport of a System

The preparations for transporting a MBRAUN System should be carried out by a MBRAUN technician only.

The transport of the system should be done by a forwarding agency specialized solely for this purpose.

If the system is part of another system line, the instructions of this system line are also valid.

2.2. Site Selection for a System

Selecting the site for a MBRAUN System of the series should be carried out by MBRAUN technicians only.

If the system is part of a system unit in addition the instructions of the unit are also valid.

Prerequisites:

Room:	Room temperature +15 °C to +30 °C, dry and well ventilated.
Surface conditions:	Firmly structured floor, no oblique position.
Clearance:	Minimum clearance from the walls is 600 mm plus sufficient access and working space where glove ports, antechambers etc. require access.

2.3. Modification of a System

In principle changes and modifications of any kind on **MBRAUN** Glove-Systems of the series should be made by **MBRAUN** technicians only.

For exceptions of any kind a written confirmation is required.

Any unauthorised change or modification to the system will cause all claims under warranty and those to liability to expire.

If the system is part of another system line, the instructions of this system line are also valid.

Contents

3.1. General Information.....	2
3.2. Working Gases.....	2
3.2.1. Working Gas	2
3.2.2. Regeneration Gas	2
3.2.3. Purge Gas.....	2
3.3. Equipment for Connections.....	3
3.3.1. Equipment for Working Gas Connections	3
3.3.2. Equipment for Regeneration Gas Connections.....	3
3.3.3. Equipment for Purge Gas	4
3.3.4. Equipment for Vacuum Pumps	4
3.3.5. Equipment for the Water Cooling	5
3.3.6. Power Connection	5

3.1. General Information

The accessories described in this chapter are required for connecting the system. They are not included in the system's delivery package.

3.2. Working Gases

3.2.1. Working Gas

<i>Use</i>	Building up and maintaining the ultra pure gas atmosphere and pressure gas for electropneumatic valves.
<i>Gas type*</i>	Nitrogen, Argon or Helium.
<i>Purity</i>	Medium Purity (4.8 or better); from bottles or other gas supplies.
<i>Quantity</i>	Permanent supply for the system's operation (e.g. for pressure compensation.)

3.2.2. Regeneration Gas

<i>Use</i>	Reprocessing saturated H ₂ O/O ₂ purifier columns.
<i>Gas type*</i>	Depending on the type of application: Nitrogen/Hydrogen mixture (90-95% N ₂ with 5-10% H ₂ - portion) when Nitrogen is used as the working gas or Argon/Hydrogen mixture (90-95% Ar ₂ with 5-10% H ₂ - portion) when Argon is used as the working gas or Helium/Hydrogen mixture (90-95% He with 5-10% H ₂ - portion) when Helium is used as the working gas.
<i>Purity</i>	Medium Purity (4.8 or better); from bottles or other gas supplies.
<i>Quantity</i>	Approx. 3,500 Litres for each Regeneration.

3.2.3. Purge Gas

<i>Use</i>	Getting the system filled up and purged with working gas (when commissioning for the first time and after servicing or repairs of the system.)
<i>Gas type*</i>	Working gas (nitrogen, argon or helium.)
<i>Purity</i>	Medium purity (4.8 or better); from bottles or other gas supply facilities.
<i>Quantity</i>	Approx. 10 - 12 m ³ /m ³ box volume for purging the system when commissioning the system for the first time or intermediately purging the system.

Note:

Other gas mixtures, including those with carbon dioxide and hydrogen, are possible. These require special preparation by **MBRAUN**. Preparation to facilitate the use of such gases is not included in the standard system – therefore only gas mentioned in table above should be used.

3.3. Equipment for Connections

Prior to delivery of the system the user will receive an information sheet specifying the necessary accessories required to make the connections. The following specifications are a general overview.

3.3.1. Equipment for Working Gas Connections

Pressure Reducing Valve for Working Gas

<i>Use</i>	working gas pressure control system.
<i>Material</i>	200 bar primary, 5.5-6.0 bar secondary, with a flow rate of 200 l/min
<i>Connection type</i>	Ø 9 mm hose or Ø 10 mm Swagelok® fitting.

Supply Piping for Working Gas

<i>Use</i>	Connecting the working gas source with the “Working Gas INLET” system connection.
<i>Material</i>	Optional (length as required): either: Ø 9 mm reinforced hose, 3 mm wall thickness and adapter, Ø 9 mm hose nozzle with Ø 10 mm Swagelok® fitting or: Ø 10 mm copper pipe and Ø 10 mm Swagelok® fitting or: Ø 10 mm stainless steel pipe and Ø 10 mm Swagelok® fitting.
<i>Connection type</i>	Ø 9 mm hose nozzle or Ø 10 mm Swagelok® fitting.

3.3.2. Equipment for Regeneration Gas Connections

Note:

MBRAUN recommends the use of a special pressure reducing valve fitted with a non-standard secondary gauge that is calibrated between 0 – 1.5 bar.
This is available from MBRAUN – Part No. 2411006.

Pressure Reducing Valve for Regeneration Gas

<i>Use</i>	Regeneration pressure control system.
<i>Material</i>	200 bar primary, 0.3-0.4 bar secondary, with a flow rate of 20 l/min
<i>Connection type</i>	Ø 9 mm hose or Ø 10 mm Swagelok® fitting.

Supply Piping for Regeneration Gas

<i>Use</i>	Connecting the working gas source with the “Regeneration Gas INLET” system connection.
<i>Material</i>	Optional (length as required): either: Ø 9 mm reinforced hose, 3 mm wall thickness and adapter, Ø 9 mm hose nozzle with Ø 10 mm Swagelok® fitting or: Ø 10 mm copper pipe and Ø 10 mm Swagelok® fitting or: Ø 10 mm stainless steel pipe and Ø 10 mm Swagelok® fitting.
<i>Connection type</i>	Ø 9 mm hose nozzle or Ø 10 mm Swagelok® fitting.

Exhaust Outlet for Waste Regeneration Gas

<i>Use</i>	Connecting the “Regeneration Gas OUTLET” system connection with the customer’s disposal facility (exhaust outlet).
<i>Material</i>	Optional (length as required): either: Ø 9 mm reinforced hose, 3 mm wall thickness and adapter, Ø 9 mm hose nozzle with Ø 10 mm Swagelok® fitting or: Ø 10 mm copper pipe and Ø 10 mm Swagelok® fitting or: Ø 10 mm stainless steel pipe and Ø 10 mm Swagelok® fitting.
<i>Connection type</i>	Ø 9 mm hose nozzle or Ø 10 mm Swagelok® fitting.

3.3.3. Equipment for Purge Gas**Pressure Reducing Valve for Purge Gas**

Required only for the “manual purging” method.

When using the optional “**MBRAUN** QuickPurge” purging method no preparations are required, in this case the working gas connection is used.

<i>Use</i>	Pressure control of the purge gas when manual purging is applied.
<i>Material</i>	200 bar primary, 5-6 bar secondary, with a flow rate of 200 l/min
<i>Connection type</i>	Ø 9 mm hose or Ø 10 mm Swagelok® fitting.

Supply Piping for Purge Gas

Required only for the “manual purging” method.

When using the optional “**MBRAUN** QuickPurge” purging method no preparations are required, in this case the working gas connection is used.

<i>Use</i>	Connecting the purge gas source to the purge hose.
<i>Material</i>	Ø 9 mm reinforced hose, 3 mm wall thickness length as required.

3.3.4. Equipment for Vacuum Pumps**Disposal Piping for Vacuum Pump Waste Gas**

<i>Use</i>	Connecting the vacuum pump exhaust (oil mist and waste gas) with the customer’s waste gas disposal facility (depressurized exhaust outlet).
<i>Material</i>	Optional (length as required): either: Ø 16 mm reinforced hose and Ø 16 mm hose nozzle or: Ø 16 mm copper pipe as well as flange and clamp or: Ø 16 mm stainless steel pipe as well as flange and clamp.

3.3.5. Equipment for the Water Cooling

Not applicable for systems with no cooling or equipped with compressor cooling.

Cooling Water

<i>Use</i>	System cooling
<i>Material</i>	Mains water Temperature: 15 °C – 25 °C Flow rate: 2 l/min at 10 °C, 5 l/min at 15 °C Inlet pressure: 2.0 – 4.0 bar Outlet pressure: Depressurised (max 0.5 mbar) Conductivity (@ 25°C) 0.3 – 10 mS/cm [resistivity (@ 25°C)] [3 – 0.1 MΩ/cm] pH 7 - 8 Particulate contamination filtered to a particle size (diameter) of ≤ 30 µm Micro-biologicals (algae, bacteria, fungi) none Total dissolved solids ≤ 50 ppm

Supply Piping for Water Cooling (supply and drain piping)

<i>Material</i>	Optional (length as required): either: Ø 9 mm reinforced hose, 3 mm wall thickness and adapter, Ø 9 mm hose nozzle with Ø 10 mm Swagelok® fitting or: Ø 10 mm copper pipe and Ø 10 mm Swagelok® fitting or: Ø 10 mm stainless steel pipe and Ø 10 mm Swagelok® fitting.
-----------------	--

3.3.6. Power Connection

Depending on the system, refer to Type Plate.

Blank Page

Contents

4.1. Safety Instructions	2
4.2. Connecting the System	2
4.2.1. Connecting the Working Gas.....	2
4.2.2. Connecting the Regeneration Gas	2
4.2.3. Connecting the Disposal Piping for Used Regeneration Gas	3
4.2.4. Connecting the Disposal Piping for Vacuum Waste Gases	3
4.2.5. Connecting the Cooling Water.....	3
4.2.6. Electric Power Connection	3

4.1. Safety Instructions

It is recommended that only a competent MBRAUN technician complete the initial system installation.

Caution:

Risk of accident whilst handling gases. Connection of systems should only be carried out by competent and experienced personnel.

MBRAUN standard systems are not suited for using radioactive or toxic agents. In such a case, special equipment components are required as well as special methods for the connections and precautions have to be observed. These are NOT described in this technical documentation. If necessary, the MBRAUN service department will provide you with the pertinent information!

(e-mail: service@mbraun.de)

4.2. Connecting the System

4.2.1. Connecting the Working Gas

1. Connect the pressure-reducing valve to the working gas source.
Follow the manufacturer's given instructions for its connection.
 2. Make a supply line between the working gas source and the "Working Gas - INLET" system connection.
Follow "Preparing the connections" chapter.
 3. The "Working gas INLET" system connection is labelled with the exact value for the supply pressure.
Set pressure reducing valve to this value and open valve.
-

Caution:

Exact pressure setting required.

Overpressure will damage the system - low pressure will cause malfunction.

4.2.2. Connecting the Regeneration Gas

1. Connect the pressure reducing valve to the regeneration gas source.
Follow the manufacturer's given instructions for its connection
 2. Connect the working gas source with the "Regeneration Gas INLET" system connection using the supply pipe.
Follow Chapter "Preparing the Connections"
 3. The "Regeneration Gas INLET" system connection is labelled with the exact value for the supply pressure.
Set pressure reducing valve to this value and open valve.
-

Caution:

Exact pressure setting required.

Overpressure will damage the system - low pressure will cause malfunction.

4.2.3. Connecting the Disposal Piping for Used Regeneration Gas

1. Connect the disposal piping between the "Regeneration gas OUTLET" system connection and the customer's disposal facility (exhaust).
2. Connection must be depressurised.

Caution:

A foul bad smell is to be expected, as soon as any spent regeneration gas escapes to the surroundings. Neither environmental pollution nor effects detrimental to health are known. However, these cannot be excluded. The manufacturer does not assume any liability.
When using toxic or radioactive material, there should be no discharge of the gas to surroundings.

4.2.4. Connecting the Disposal Piping for Vacuum Waste Gases

1. Connect the disposal piping between the vacuum pump exhaust and the customer's disposal facility (exhaust).
Follow the manufacturer's instructions for the vacuum pump connections.
2. Connection must be depressurised.

Note:

Depending on the place where the vacuum pump is used an oil mist filter can be used instead of the disposal piping. Important information and supply details may be obtained from: service@mbraun.de

4.2.5. Connecting the Cooling Water

Not required in systems without cooling or fitted with compressor cooling.

1. Connect the "Cooling water INLET" system connection to the cooling water source.
Follow "Preparing the Connections" chapter.
2. Connect the "Cooling water OUTLET" system connection to the depressurized water disposal.
Follow "Preparing the Connections" chapter.
3. Turn on the cooling water. The cooling water flow rate setting depends on the available water temperature, see "Preparing the Connections" chapter.

4.2.6. Electric Power Connection

The connection needs to be made to protected (fused) power supply that is equipped with a CPC (earth conductor). The required values for connection should be taken from the type plate.

Blank Page

Contents

5.1. Prerequisites	2
5.2. Activating the System	2
5.3. Start Messages.....	2
5.4. Deactivating the System	3

Table of Figures

Figure 1: Main Switch.....	2
Figure 2: Touch Panel.....	2
Figure 3: Start Screen	3

5.1. Prerequisites

- All previous chapters observed
- Working gas connection properly made
- Regeneration gas connection properly made
- Exhaust facility for waste regeneration gas properly made
- Purge gas connection properly made
- Exhaust facility for vacuum pump waste gas properly made
- Cooling water connection properly made; not required in systems with compressor cooling.
- Power connection properly made
- All piping and connections checked for its condition and firm mounting.

5.2. Activating the System

Figure 1: Main Switch



The main switch is located at the system's electrical cabinet.

Activating the system:
Turn the main switch from the "O OFF" to position "I ON".

5.3. Start Messages

MBRAUN-Systems provided with the **TOUCH** Panel in the standard design have the panel located in a clearly visible central position.

After being activated, the system runs a self-test

Figure 2: Touch Panel

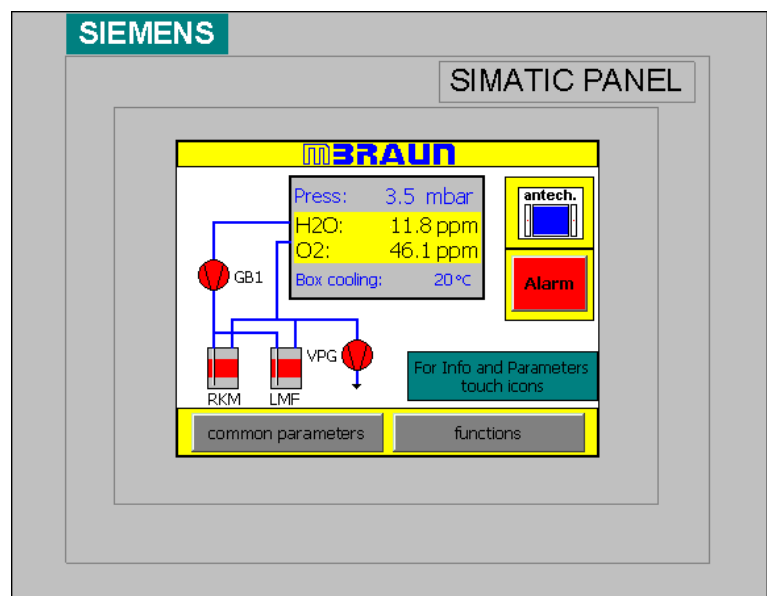
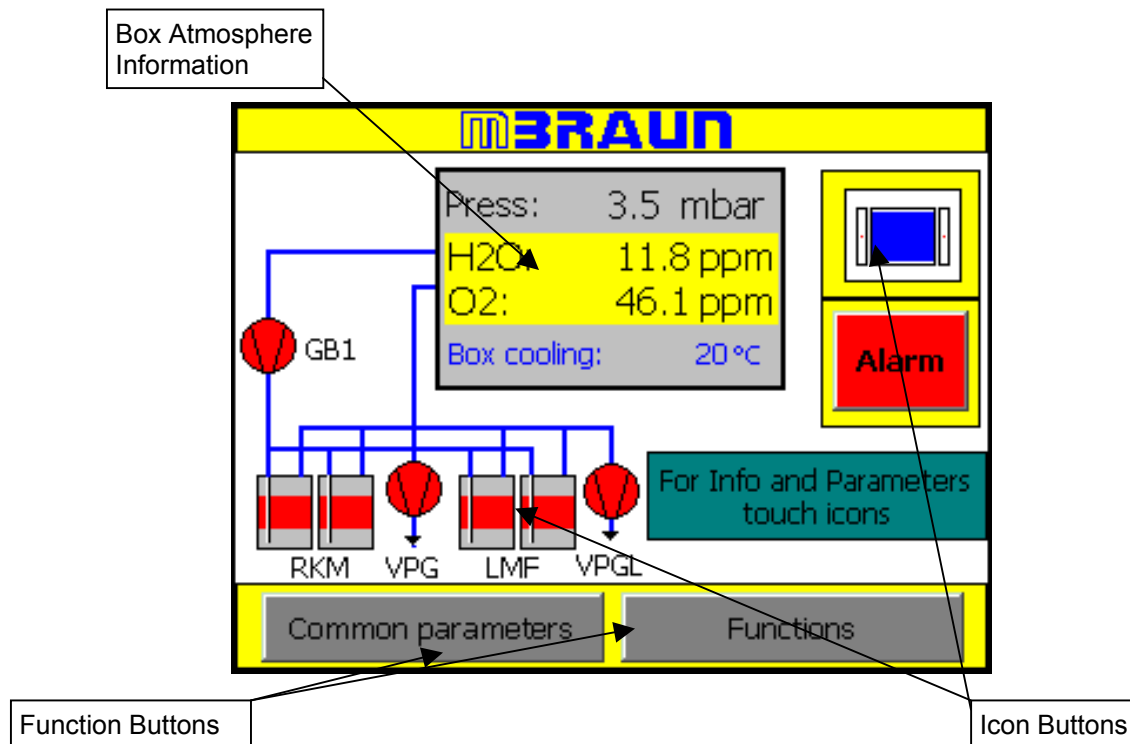

Figure 3: Start Screen



The Diagram above shows a typical “Start Screen”. The various icons will change depending on the system chosen.

The system above would have the following:

- 2 Purifier Filters
- 2 Solvent removal filters
- Cooling unit for the glove box
- Automatic antechamber controls.

The Touch Screen consists of a pictorial representation of the System.

The Functions are controlled by means of “Function Buttons” or “Icon Buttons”.

Upon start-up, the Start Screen is displayed. The Start Screen displays an overview of the Box status in an information field.

5.4. Deactivating the System

The system should not be deactivated until all running procedures, such as circulation and regeneration have been completed and deactivated.

Caution
Do not deactivate the system with procedures running (circulation, regeneration.)

The main switch is located on the system’s wiring cabinet, see subsection “Activating the system”.

Deactivating the system:

Turn main switch from “I ON” Position to “0 OFF”.

Blank Page

Contents

6.1. Overview	2
6.2. Display	2
6.3. Function Buttons	2
6.3.1. Status of Function	3
6.4. Icon buttons	3
6.4.1. Status of Purifier Filters	3
6.5. Navigation Buttons	4
6.6. Input Fields and Buttons.....	4

Table of Figures

Figure 1: Touch Panel.....	2
Figure 2: Input Fields	4
Figure 3: Keypads.....	4

6.1. Overview

The TOUCH Panel is the system's central operation and display unit. This unit is located at a clear and well accessible position.

Figure 1: Touch Panel

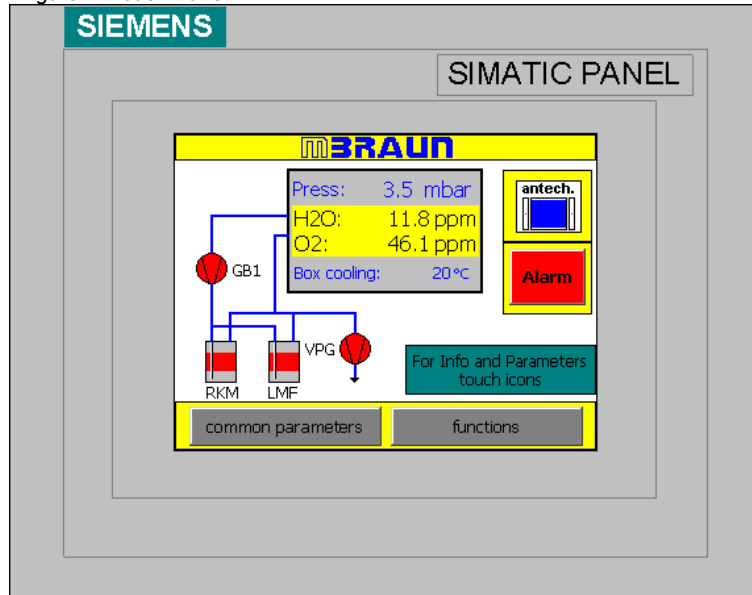

6.2. Display

The Touch Screen consists of a pictorial representation of the System.

6.3. Function Buttons

The Functions can be controlled by means of "Function Buttons" or "Icon Buttons".

The Function Buttons are labelled with an appropriate description for its function. As shown below:



- Common parameters

Common Parameters – this button will open the Common Parameters screen.
- Functions

Functions - this button will open the Functions screen.

6.3.1. Status of Function

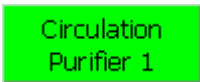
The TOUCH panel also allows for the Function status to be displayed. This feedback is relayed to the user by varying the colour of the Function Button as below:

	RED	Not Active
	GREEN	Active
	GREY	Function not available (Function Locked)

6.4. Icon buttons

The Icon Buttons are a pictorial representation of the item that it controls.

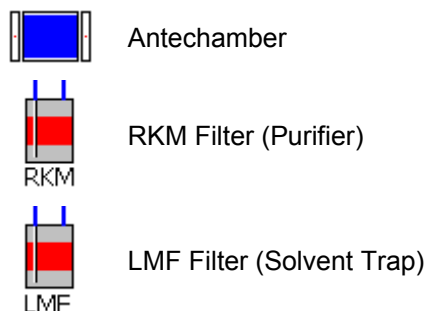

6.4.1. Status of Purifier Filters

The statuses of the Purifier Filters, including those for the Solvent Trap (LMF) Filter, if applicable, are indicated by the icon colour.

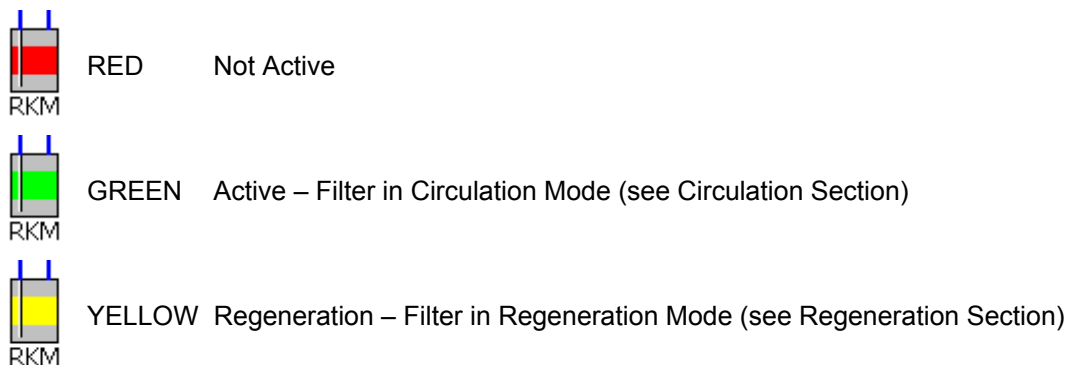

6.5. Navigation Buttons

The TOUCH panel utilises the same colours and labels for navigation from screen to screen throughout. The buttons and their function are as below:

NEXT	NEXT – If this button is displayed within a screen then there are more screens to follow. Selecting this button will present you with a new screen of options within the function series.
BACK	BACK – This button will always take you to the previous screen in the function series. The last step backwards will return you to the Start Screen.
END	END – This button will always return you to the Start Screen.
Alarm	Alarm – This button will always open the Alarm/Error Message Screen. If the Alarm button is flashing then there is a message that needs to be acknowledged on the Alarm/Error Message Screen.

6.6. Input Fields and Buttons

All input fields are shown with blue text on a light grey background.

For entering Passwords, setting the system parameters or alarms, or selecting certain options the TOUCH panel utilises Input field as shown below.

Figure 2: Input Fields

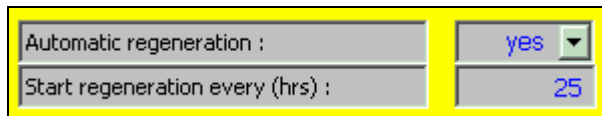

There are two types of Input field.

The first type, shown in figure 2, has a pull-down menu. If the screen area for this field is touched in the input area then an options menu will be displayed. The required option is selected by touching the screen. The entry is confirmed by the pull-down menu being removed from the display, and the required selection being displayed in the input field. E.g. “yes” or “no” appears in the input field.

The second type, shown in figure 2, is an alpha/numeric input field. If the screen is touched in the input area then an alpha/numeric pad will be displayed, see Figure 3. Entry of the required data is made buy pressing each button and then must be confirmed by selecting the “Enter Button”. On confirmation that the data is correct the keypad is removed from the display and the up-dated value is entered into the input field.

Figure 3: Keypads

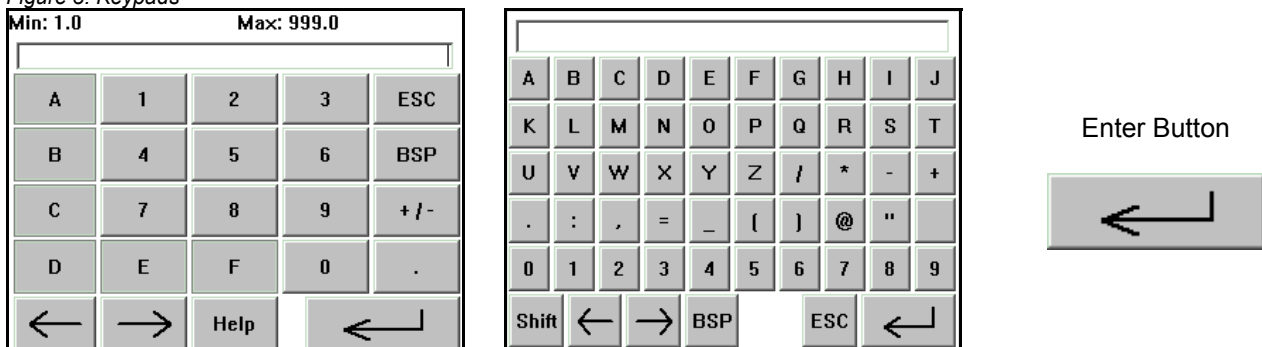

Contents

7.1. General Information.....	2
7.2. When is Purging Necessary?	2
7.3. Purge Gas	2
7.4. Purging Methods.....	3
7.5. Manual Purging	3
7.5.1. Prerequisites:	3
7.5.2. Purging Procedure:	3
7.6. Automatic Purging.....	4
7.6.1. Prerequisites:	4
7.6.2. “Quick Purge” Procedure.....	5
 Table of Figures	
<i>Figure 1: Example of Purge Gas consumption</i>	<i>2</i>
<i>Figure 2: Manual Purging Procedure</i>	<i>4</i>

7.1. General Information

Glove-Box systems either newly installed or opened for reasons of service contain ambient air. The prerequisite for the gas purification is a pure gas atmosphere of nitrogen, argon or helium within the box. Thus, at the beginning of the system's commissioning the ambient air should be replaced by nitrogen, argon or helium of medium purity.

Displacing the ambient air from the system is called purging. Working gas is used as purging gas.

7.2. When is Purging Necessary?

On principle, a system should be purged, when the O₂ portion in the box atmosphere exceeds 100ppm.

The reasons for too high oxygen values are as follows:

- first commissioning of a system
- servicing
- air influx due to faulty operation
- air influx due to damage (leaks)

Caution:
 A Glove-Box system should be purged using working gas until the O₂ portion within the box atmosphere has decreased to a value of <100 ppm. Operating the system with higher oxygen value may result in damaging the gas purification system.

7.3. Purge Gas

Working gas is used for purging the system;
 Nitrogen, argon or helium - medium purity - from bottles or any gas supply facilities.

Figure 1: Example of Purge Gas consumption

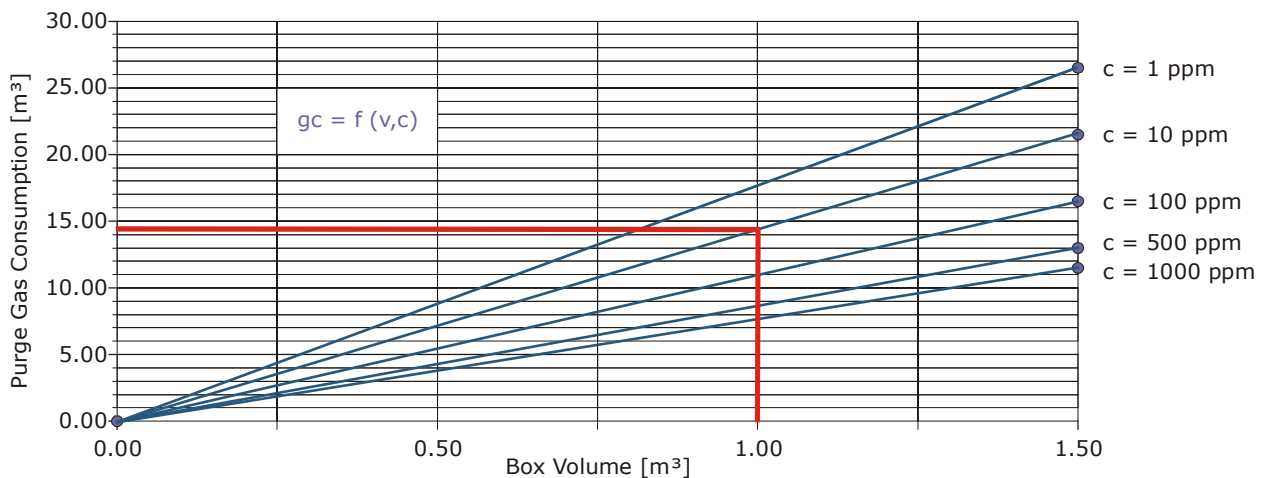

In the example, it shows that if a purity of 10 ppm is required, then about 14.50m³ of purge gas is required for 1 m³ box volume.

7.4. Purging Methods

Manual Purging.
Automatic Purging.

7.5. Manual Purging

Caution:

Annoyance by bad smell is expected as soon as any spend purge gas escapes to the surroundings. However, environmental pollution and effects detrimental to health are not known, but cannot be excluded. The manufacturer does not assume any liability.

When using toxic or radioactive material manual a special purging facility is required.

7.5.1. Prerequisites:

- | | |
|-------------------------------------|---|
| <input checked="" type="checkbox"/> | Having observed all previous chapters. |
| <input checked="" type="checkbox"/> | All connections have been properly made. |
| <input checked="" type="checkbox"/> | The system functions "Circulation" and "Regeneration" are not activated |
| <input checked="" type="checkbox"/> | All antechamber doors are closed. |
| <input checked="" type="checkbox"/> | The connections for manual purging have been made, refer to chapter "Preparations for connections". |
| <input checked="" type="checkbox"/> | Sufficient working gas (i.e. purge gas) is available.
Required quantity approx. 10 – 12 m ³ /m ³ box volume. |

7.5.2. Purging Procedure:

(See figure 2)

- Set-up purge gas source (working gas) with pressure reducing valve.
- Connect reinforced hose to purge gas source.
- Open "blind flange" on Glove-Box.
- Feed one end of the reinforced hose through the open flange into the glove.
- Set the pressure reducing valve on the purge gas source between 3-5 bar and open valve.
- Using the gloves, take hold of the reinforced hose and purge the box interior from top to bottom using a circular motion. Carefully purge corners, edges and box fittings.
- Systems equipped with freezers, or have areas that may be protected by covers, will need to be open during the purging process (ensure that freezers are switched off and at room temperature.)
- Air and excess purge gas escapes through the flange opening.
- Purge until the box O₂ value has reached <100 ppm.

To reach this value it may require between 10 - 12 m³/m³ box volume of purge gas

With systems that have analysers the actual O₂-value can be precisely controlled. It is recommended that the O₂ analysers are switched on for a short time to allow a reading to be taken during the purge process. The measurement may settle at a higher H₂O/O₂-concentration.

After reaching an O₂-value of <100 ppm the reinforced hose may be removed from the box and the flange **immediately** closed.

- Turn off purge gas flow.

Figure 2: Manual Purging Procedure

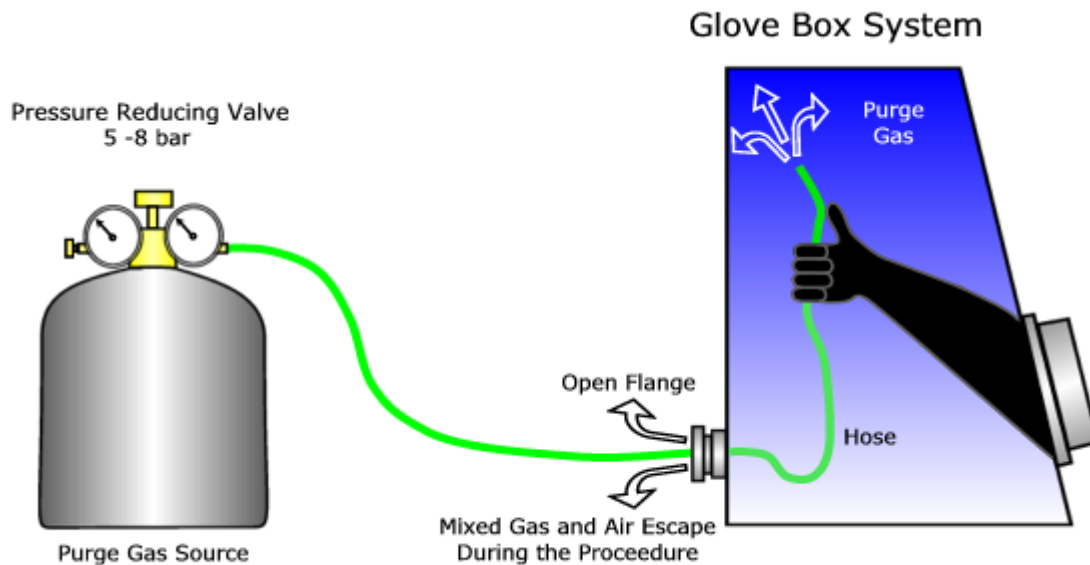

7.6. Automatic Purging

The "MBRAUN QuickPurge" automatic purging system is an optional component for pleasurable operating the system.

Caution:

Annoyance by bad smell is expected as soon as any spent purge gas escapes to the surroundings. However, environmental pollution and effects detrimental to health are not known, but cannot be excluded. The manufacturer does not assume any liability. When using toxic or radioactive material manual a special purging facility is required.

7.6.1. Prerequisites:

- Having observed all previous chapters.
- All connections have been properly made.
- The working gas connection has been made; refer to Chapter "Preparations for Connections" and Chapter "Installation".
- The system is activated; refer to Chapter "Activating the system".
- The system function "Regeneration" is not activated.
- All antechamber doors are closed.
- Systems equipped with freezers, or have areas that may be protected by covers, will need to be open during the purging process (ensure that freezers are switched off and at room temperature.)
- Sufficient working gas (i.e. purge gas) is available.
Required quantity approx. 10 - 12 m³ / m³ box volume.

7.6.2. "Quick Purge" Procedure

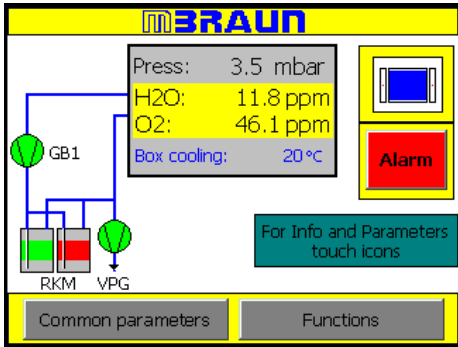

From the Start Screen select the "Functions" Button

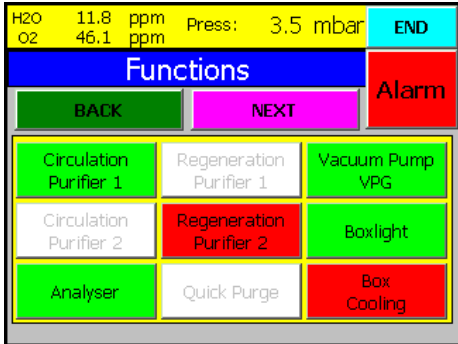

Note:
The Quick Purge function is locked (can not be activated) whilst the circulation function is in operation.

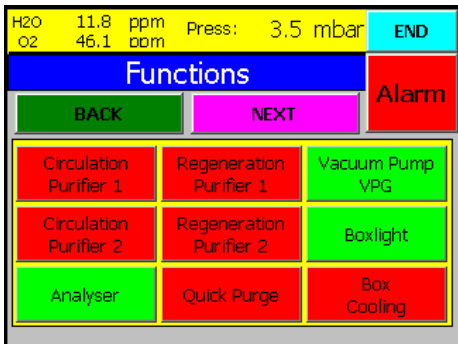

To release the "Quick Purge" button the circulation mode must be switched off by pressing the Circulation Purifier button that is in operation

The Circulation Purifier buttons will change from green to red to indicate that the function has been deactivated.

The Quick Purge button will change to Red, confirming that the function is no longer locked but still is deactivated.

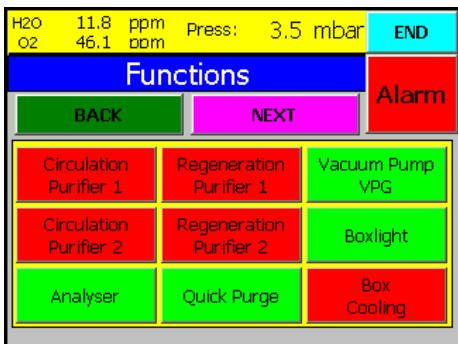

The Quick Purge function is activated but selecting the Quick Purge button. The button will change to its active status – green.

Pressing the Quick Purge button again will deactivate the function.

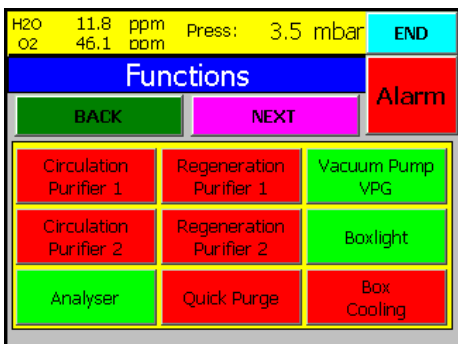

Note:
Pressing the Circulation Purifier button will return the box to Circulation Mode immediately. The Quick Purge function will again become locked.

Blank Page

Contents

8.1. General Information.....	2
8.2. Principles.....	2
8.3. Definitions of Terms	3
8.4. Changing the Box Pressure within the Working Range	4
<i>Table of Figures</i>	
<i>Figure 1: Principles of Pressure Control</i>	<i>2</i>
<i>Figure 2: Footswitch.....</i>	<i>4</i>

8.1. General Information

MBRAUN Glove Box systems are equipped with a PLC-controlled pressure control system which starts automatically with the main system's activation.

8.2. Principles

Figure 1: Principles of Pressure Control

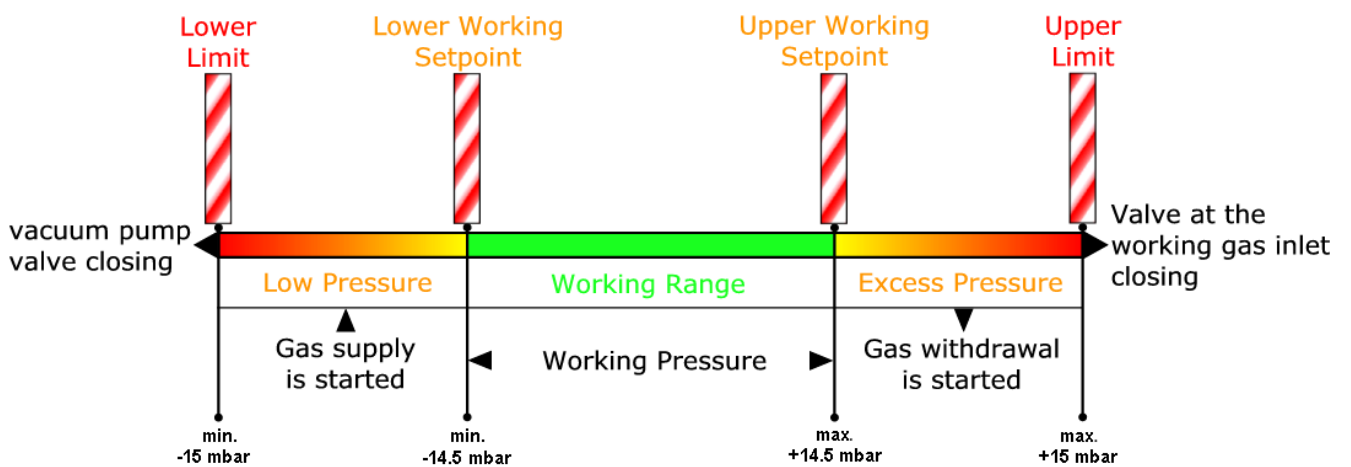

8.3. Definitions of Terms

Box pressure	Current pressure prevailing within the glove box.
Working pressure	Box pressure desired.
Working range	A fixed range within the working setpoints of which the working pressure may travel between under automatic control.
Working setpoints	Adjustable setpoints of the working range from -14.5 mbar to $+14.5$ mbar. If these setpoints are exceeded automatic pressure compensation is started. The upper working setpoint value should at least be 1 mbar higher than the lower working setpoint value. <i>The manufacturer's settings:</i> <i>upper working setpoint +4 mbar; lower working setpoint -4 mbar.</i> For working setpoints modifications refer to "Settings" chapter and display types.
Limit setpoints	Adjustable maximum pressure setpoints outside working range for the system's safety (-15 mbar to $+15$ mbar), if these setpoints are exceeded the gas supply valves or gas withdrawal valves are closed immediately. <i>The manufacturer's settings:</i> <i>upper limit setpoint +15 mbar; lower limit setpoint -15 mbar.</i> For alarm setpoint modifications refer to "Settings" Chapter.

8.4. Changing the Box Pressure within the Working Range

MBRAUN Glove Box systems of this series are equipped with a foot switch. The box pressure can conveniently be changed within the working range by actuating the foot switch.

8.4.1. Operation of the Foot Switch

Pressing the right pedal	Pressure increases within the working range.
Pressing the left pedal	Pressure decreases within the working range.

Figure 2: Footswitch



Foot switch

Contents

9.1. General Information..... 2

9.2. Status of Purifier Filters 2

9.3. Prerequisites 2

9.4. Circulation Mode..... 3

 9.4.1. Activating and Deactivating the Circulation Mode 4

 9.4.2. Automatic Start of Circulation Mode 5

Table of Figures

Figure 1: Principle of Circulation 2

Figure 2: Status of Purifiers 2

Figure 3: Circulation in Box 3

9.1. General Information

Figure 1: Principle of Circulation

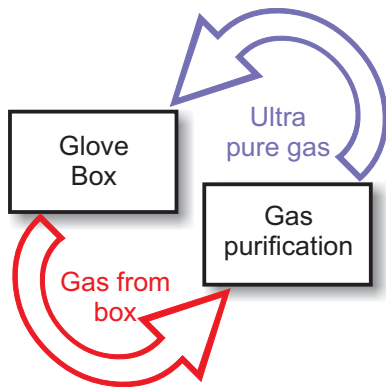

MBRAUN systems work by the principle of gas circulation, i.e. the working gas permanently circulates between the glove box and the H₂O/O₂ gas purification system. This process guarantees absolutely stable values of gas purity and cost-efficient processing.

Caution:

When operating the Glove Box system the circulation mode should always be activated. Only in this case the atmosphere within the glove box is continuously purified to values down to < 1 ppm with regard to moisture and/or oxygen.

The circulation mode is PLC-controlled and is operated and displayed via the *TOUCH* Operation Panel (TP170b).

When used for quite a long period in the circulation mode the purification unit gets exhausted resulting in a drop of the purification performance leading to increasing H₂O/O₂ values. For this reason, the purifier column should be regenerated regularly or at the latest when there is a visible drop in performance. Refer to the "Regeneration" chapter.

The circulation mode should be deactivated while the regeneration procedure is running.

In systems with 2 purifier columns circulation mode can run via one purifier column while the other purifier column is undergoing regeneration.

9.2. Status of Purifier Filters

The Status of the Purifier Filters can be seen at all times on the start screen. The Icon for the filter differs for each mode. As show in figure 2.

Figure 2: Status of Purifiers

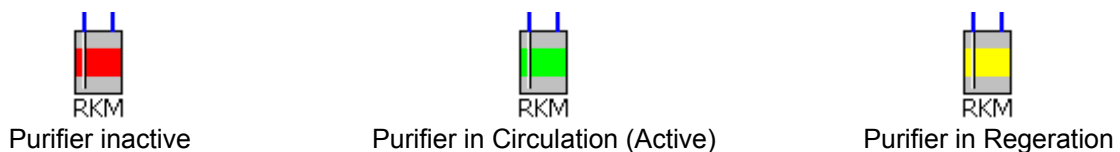

9.3. Prerequisites

- All preceding chapters have been observed
- All connections are properly made.
- All antechamber doors are closed.
- The Glove Box system has been purged.
- The system is activated.
- No regeneration of the purifier column.

9.4. Circulation Mode

Note:

The principle for circulation is the same for both 1 and 2 filter systems.

The two purifier system allows greater flexibility in operation of the box by allowing one filter to be regenerated whilst the other is in circulation (purifying) Mode.

The position of buttons with the Touch Panel (TP170B) is the same for both systems. However only those relevant to the system supplied are displayed.

Figure 3: Circulation in Box

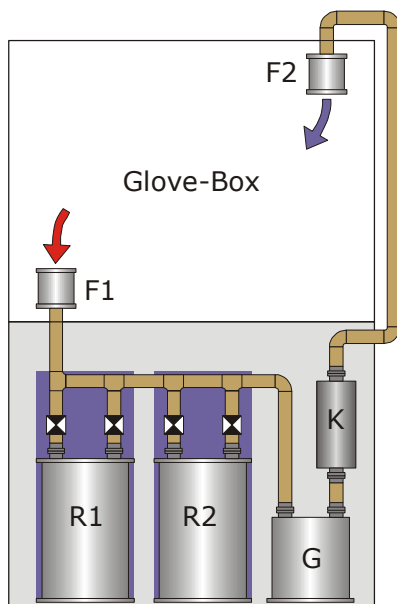

The diagram shows the gas flow in the circulation mode:
(2 Purifier Column System)

- Glove Box
- Dust filter (F1)
- purifier column
either:
H₂O/O₂-Purifier column 1 (R1) in circulation mode
H₂O/O₂-Purifier column 2 (R2) can be regenerated
or:
H₂O/O₂-Purifier column 2 (R2) in circulation mode
H₂O/O₂-Purifier column 1 (R1) can be regenerated
- Blower unit (G)
- Heat exchanger (K)
- Dust filter (F2)

Note:

Circulation cannot run simultaneously through both columns.

Note:

When commissioning the system for the first time, the circulation mode can be run via Purifier column 1, which was regenerated by the manufacturer prior to delivery.

Purifier column 2 should be regenerated before being used in circulation mode.

9.4.1. Activating and Deactivating the Circulation Mode

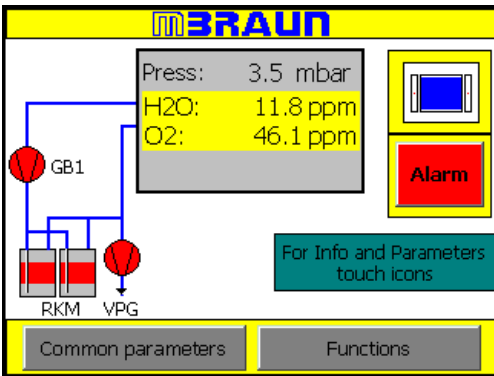

Select the Functions button on the Start screen

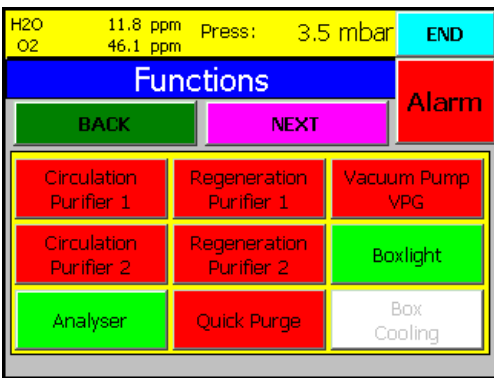

Select the Circulation Purifier button (red) to start the Circulation Mode.

Note:
Circulation can only be made via one purifier at any time.

Note:
If a filter is in Regeneration Mode the regeneration must finish before switching the filter into Circulation Mode.

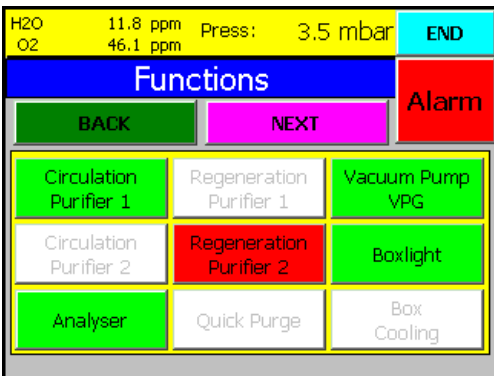

To acknowledge that the purifier is in Circulation Mode the button will change to green.

Note:
The Vacuum Pump activates automatically, if not previously activated.

The regeneration function for the selected filter will become blocked (button will display grey) until circulation over the filter is cancelled.

Note:
If the system has a second filter option this will have its circulation function blocked. Regeneration of second filter is still available.

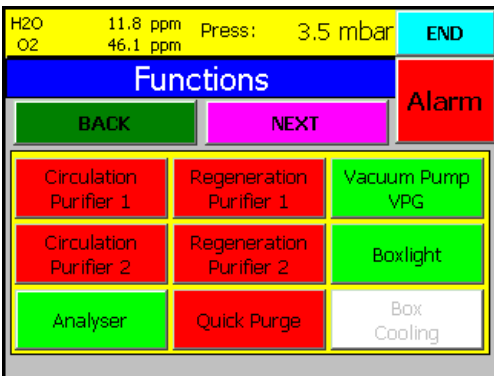

Selecting the Circulation Filter button a further time will switch off the circulation over the first purifier column.

9.4.2. Automatic Start of Circulation Mode

After regeneration of a filter has completed (see section Regeneration), it is possible to have this filter switched into Circulation Mode.

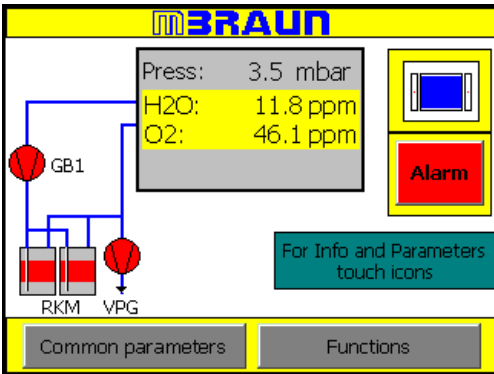

Select the Purification Filter icon on the start screen.

1 filter screen layout

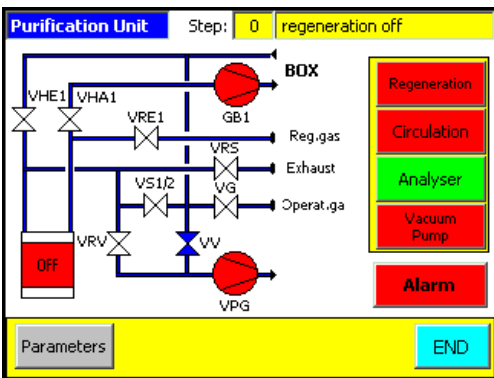

2 filter screen layout

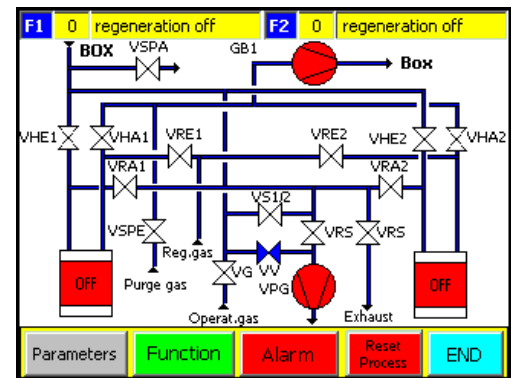

Select the Parameters button to go to the Purifier Parameter Screen

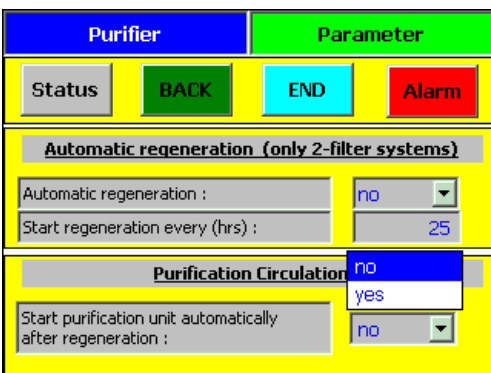

Select the input field for Purification Circulation by touching the arrow to the right of the input field.

A pull down options menu will appear. Select the option required – Yes or No.

The contents of the input field will automatically update.

Blank Page

Contents

10.1.	General Information	2
10.2.	Status of Purifier Filters	2
10.3.	Prerequisites	2
10.4.	Regeneration Program.....	3
10.4.1.	Activating the Regeneration Program	3
10.4.2.	Executing the Regeneration Program	4
10.4.3.	Regeneration Program Completed	5
10.5.	Auto-Start after Regeneration (1 Filter Systems).....	6
10.6.	Automatic Regeneration Mode.....	7
10.7.	Status of Regeneration	8
10.7.1.	Step Status	8
10.7.2.	Time Status	8

Table of Figures

Figure 1:	Status of Purifiers.....	2
Figure 2:	Regeneration Program Table	4

10.1. General Information

If a purifier column is saturated after having been used for a longer period, using the standard regeneration process will reactivate the column.

Regenerating the purifier column in regular intervals is recommended. Do not wait, until a drop in the purification performance is visible. These intervals between the respective regeneration procedures result from an experimental value, which differs depending on the respective system, way and time of use.



Recommendation:

Apply the following method for determining the reasonable intervals for regeneration: Regenerate the purifier column after its first commissioning only when a drop of performance is visible. If such a drop occurs, write the operating hours run down. The operating hours reading minus 10 hours can be used as a reference value for the intervals between the respective regeneration procedures.

10.2. Status of Purifier Filters

The Status of the Purifier Filters can be seen at all times on the start screen. The Icon for the filter differs for each mode. As show in figure 2

Figure 1: Status of Purifiers

 RKM	 RKM	 RKM
Purifier inactive	Purifier in Circulation (Active)	Purifier in Reperation

10.3. Prerequisites

- All preceding chapters observed.
- All connections properly made.
- Sufficient regeneration gas is available.
- The system is activated.
- Circulation mode has to be deactivated.
- The purifier column to be regenerated is not in the circulation mode.

10.4. Regeneration Program

10.4.1. Activating the Regeneration Program

Note:

Ensure that there is enough regeneration gas before selecting the regeneration program. A screen message will appear as a reminder to check the regeneration gas flow.

Prove flow of the regeneration gas!
If OK --> Confirm this button

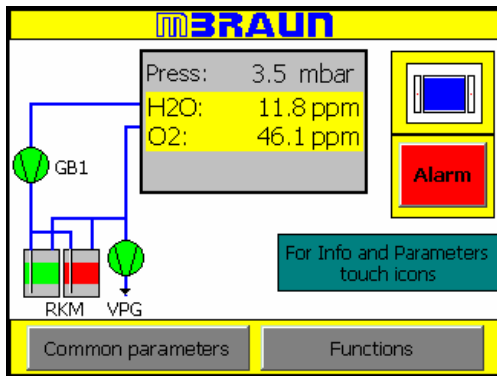

Select the Functions button on the Start Screen.

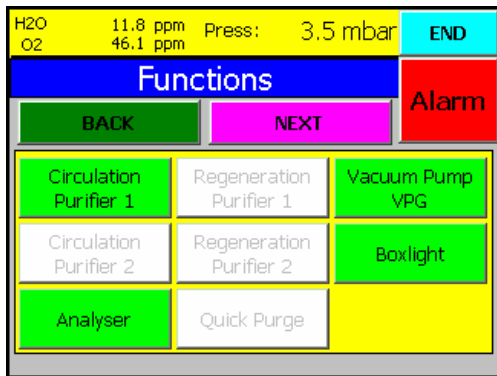

Functions screen for single filter system

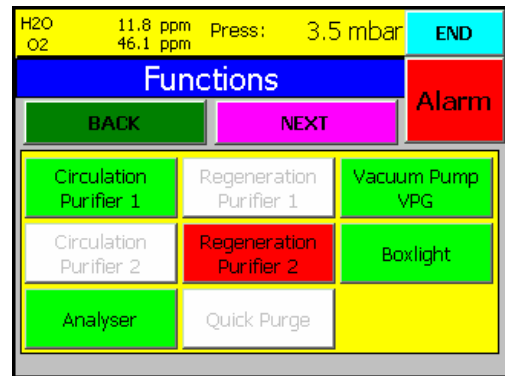

Function Screen for two filter system

Select the Regeneration button (red) to start the regeneration mode.

Note:

Regeneration can only be made via one purifier at any time. For system with one filter, the Circulation mode will need to be stopped before the "Regeneration" Button is released.



To acknowledge that the purifier is in Regeneration Mode the button will change to green. The circulation function for the selected filter will become blocked (button will display grey) until Regeneration of the filter is finished.

Note:

If the system has a second filter option this will have its regeneration function blocked. Circulation via the second filter is usually active.

10.4.2. Executing the Regeneration Program

The following table explains the various steps of the regeneration cycle. On activation of the program all the steps are run automatically.

Figure 2: Regeneration Program Table

Step	Time	Action
0	Start 0 min.	Regeneration deactivated
1		Regeneration gas test ON
2		Regeneration gas test OFF
3 - 16		Activation of the regeneration program with proprietary intermediate steps
17	after 960 min.	Program completed

Caution:

By no means the regeneration program should be interrupted. Before activating the regeneration program make sure that sufficient gas supply is available. Refer to the “Preparing the connections” as well as the “Installation” chapters.

Note:

In case of power failure the Automatic Regeneration System switches back to the activation level, which means, with the power supply restored, the complete regeneration procedure is rerun - regeneration levels already executed will be repeated. Therefore, prior to the restoration of power, make sure that sufficient gas supply is available! The program will restart automatically.

10.4.3. Regeneration Program Completed

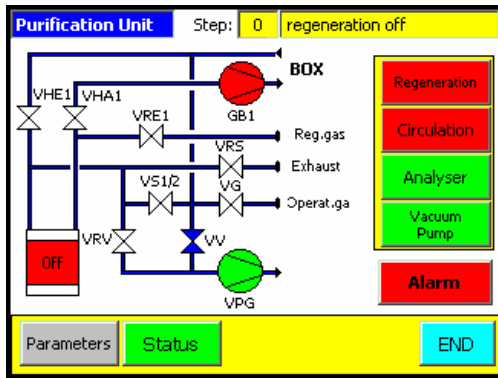

1 filter system

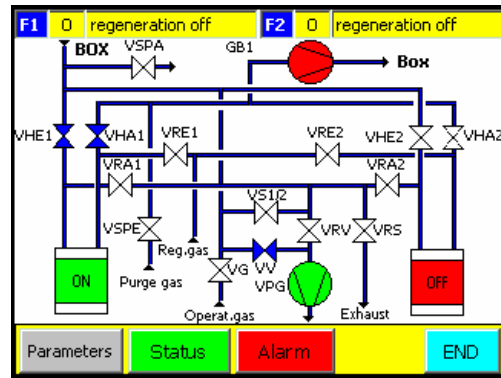

2 filter system

After being successfully executed, the regeneration program is completed automatically. With the regeneration program completed, the status indicator of the Purification Filter changes to red and the Status field at the top of the screen will read "regeneration off"

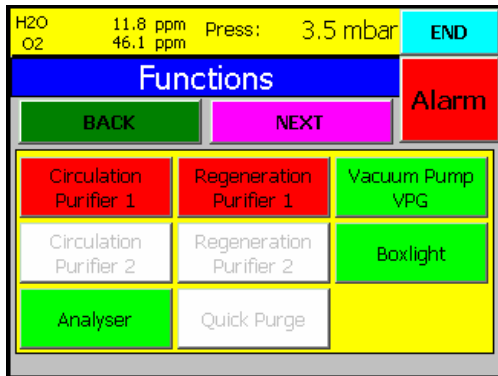

Functions screen for single filter system

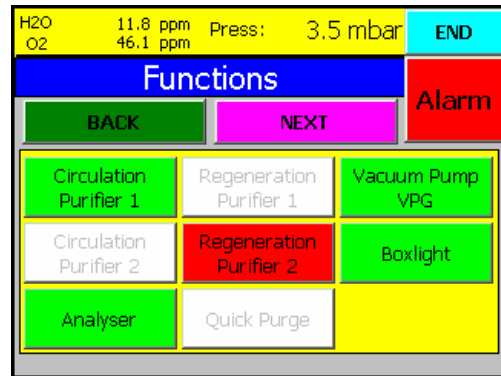

Function Screen for two filter system

The status of the filter is repeated on all relevant screens.

Above, the Functions Screens (accessed from the Start Screen) show that the regeneration mode (and Circulation mode for 1 purifier systems) have been released.

This would be repeated by the Icon Status (see status sub-section above) on the Start Screen.

10.5. Auto-Start after Regeneration (1 Filter Systems)

Recommendation:

MBRAUN recommends that for single column systems that the auto-start of the circulation after regeneration is selected.

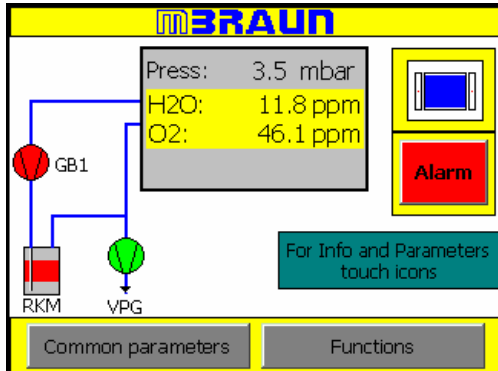

To select the "Auto Start" function from the "Start Screen" select the Purification Filter Icon.

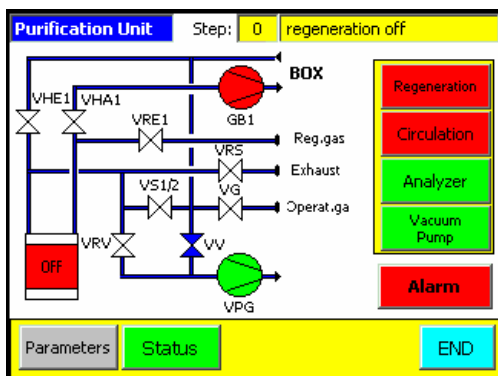

Select the Parameters Screen button.

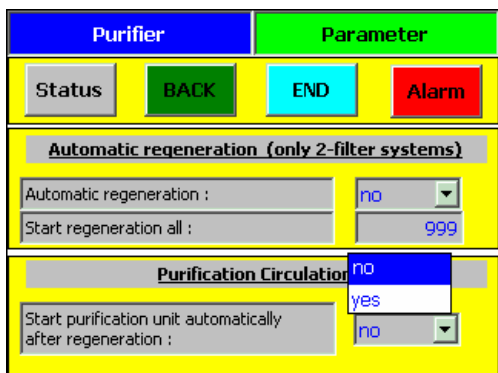

Select the input field for Purification Circulation by touching the arrow to the right of the input field.

A pull down options menu will appear. Select the option required – Yes or No.

The contents of the input field will automatically update.

10.6. Automatic Regeneration Mode

Note:
Only available for systems equipped with two purifiers.

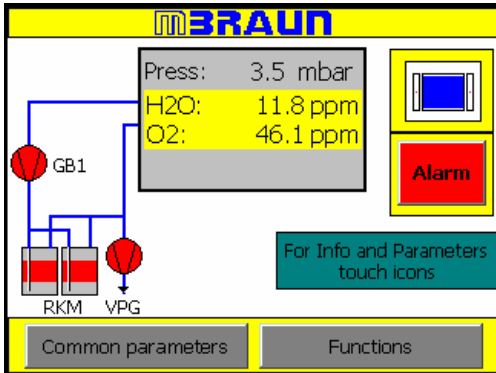

Select the Purification Filter icon on the start screen.

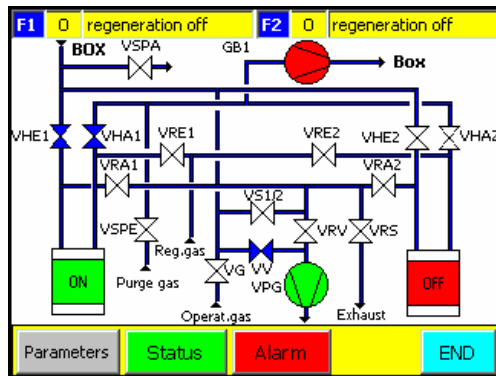

Select the Parameters button to go to the Purifier Parameter Screen

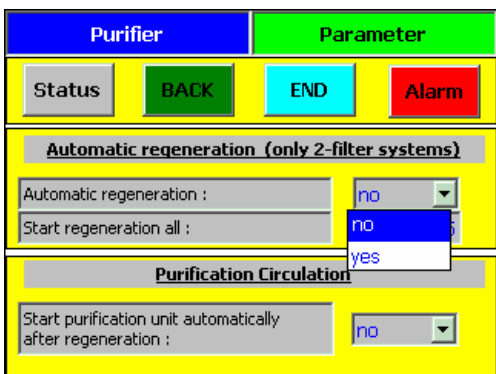

Select the input field for Automatic Regeneration by touching the arrow to the right of the input field.

A pull down options menu will appear. Select the option required – Yes or No.

The contents of the input field will automatically update.

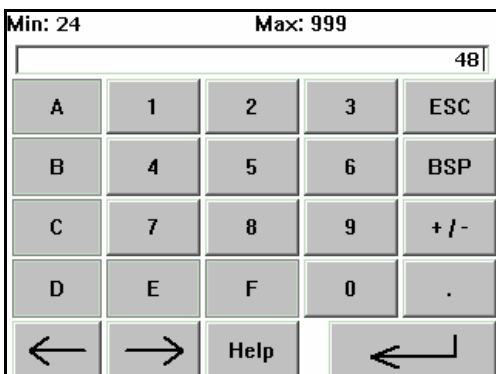

To set the intervals between each automatic regeneration cycle select the “Start regeneration” field.

The alpha-numeric pad opposite will appear.



Enter the desired value and select the enter button to input the data.

10.7. Status of Regeneration

The current status of the regeneration of the purifier filter can be seen in two ways

10.7.1. Step Status

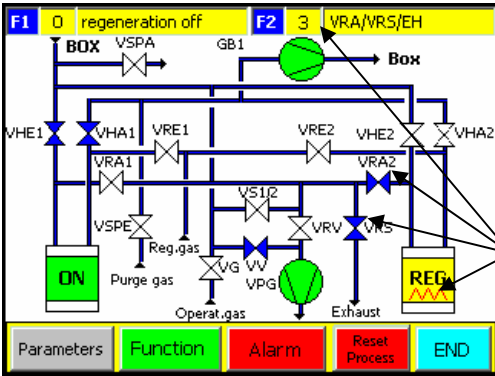

Selecting the Icon will open the screen left.

At the top of the screen is an information bar for the regeneration status of the filters.

In the diagram, on the right-hand side, you can see that the regeneration process is in its third step.

Also indicated are the components that are activate for each stage of regeneration (VRA/VRS/EH) both in the information bar and as icon on the screen.

10.7.2. Time Status

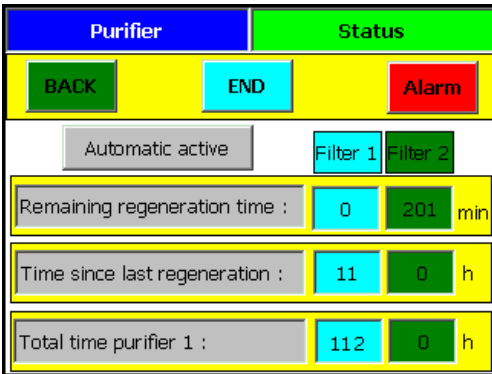

Selecting the Status button in the Purifier Parameters Screen will open the screen shown left.

This screen displays the total times for the Purification Filters (in systems with only one filter then only one set of detail are displayed.)

The Automatic Active button is Password protected – for use by MBRAUN service personnel.

Contents

11.1. General Information	2
11.1.1. Technical data:	2
11.2. Manually Operated Solvent Trap	3
11.2.1. Changing the Filter Medium	4
11.3. PLC Controlled Solvent trap	5
11.3.1. Status of Solvent Trap (LMF) Filters	5
11.3.2. Activating and Deactivating the Solvent Trap Mode	5
11.3.3. Regeneration of the Solvent Trap	6
11.4. Solvent Vapour Analyzer	7
<i>Table of Figures</i>	
<i>Figure 1: Principle of Circulation</i>	<i>2</i>
<i>Figure 2: Operation of Solvent Trap</i>	<i>3</i>
<i>Figure 3: Status of Purifiers</i>	<i>5</i>

11.1. General Information

Figure 1: Principle of Circulation

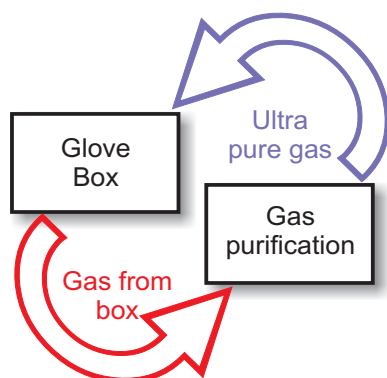

The Solvent Trap is available as an option.

It is designed to remove solvent vapours from the Glove Box Atmosphere.

The Solvent Trap works in the same manner and in series with the H₂O/O₂ gas purification system (see also chapters Circulation and Regeneration.)

The working gas permanently circulates between the glove box, the H₂O/O₂ gas purification system and the solvent removal system. This process guarantees absolutely stable values of gas purity and cost-efficient processing.

Caution:

The solvent trap filter can only remove the solvent vapour when both the solvent trap (LMF) and the H₂O/O₂ gas purification (RKM) are both in circulation mode.

There are two main types of Solvent removal systems:

Manually operated solvent trap.
PLC controlled Solvent Trap.

In systems with 2 solvent trap removal columns circulation mode can run via one column while the other column is undergoing regeneration.

The retention capability and capacity of the solvent trap depends on the type of solvent vapour to be removed from the box atmosphere.

The retention characteristics also depend upon the type of catalyst used to within the solvent trap.

Single column solvent traps and two column solvent traps without the regeneration option are filled with activated carbon.

Regenerable solvent traps are filled with a certain type of molecular sieve.

MBRAUN solvent traps are optimised for the removal of certain aromatic organic solvents, as well as, a variety of aliphatic organic solvents.

11.1.1. Technical data:

Amount of filling: 5 kg of activated carbon (article no. 2182000)
Suitably: for aromatic and aliphatic as well as halogenated organic solvents; petrol, kerosene, butyric acid; in other cases the suitability must be confirmed by **MBRAUN**.
Absorption capacity: ca. 100 g solvent per kg of activated carbon. However, the exact quantity depends on the type of the solvent and the ambient conditions - in particular the ambient temperature.

11.2. Manually Operated Solvent Trap

The diagram below shows the valve positions for operation of the Solvent Trap Unit.

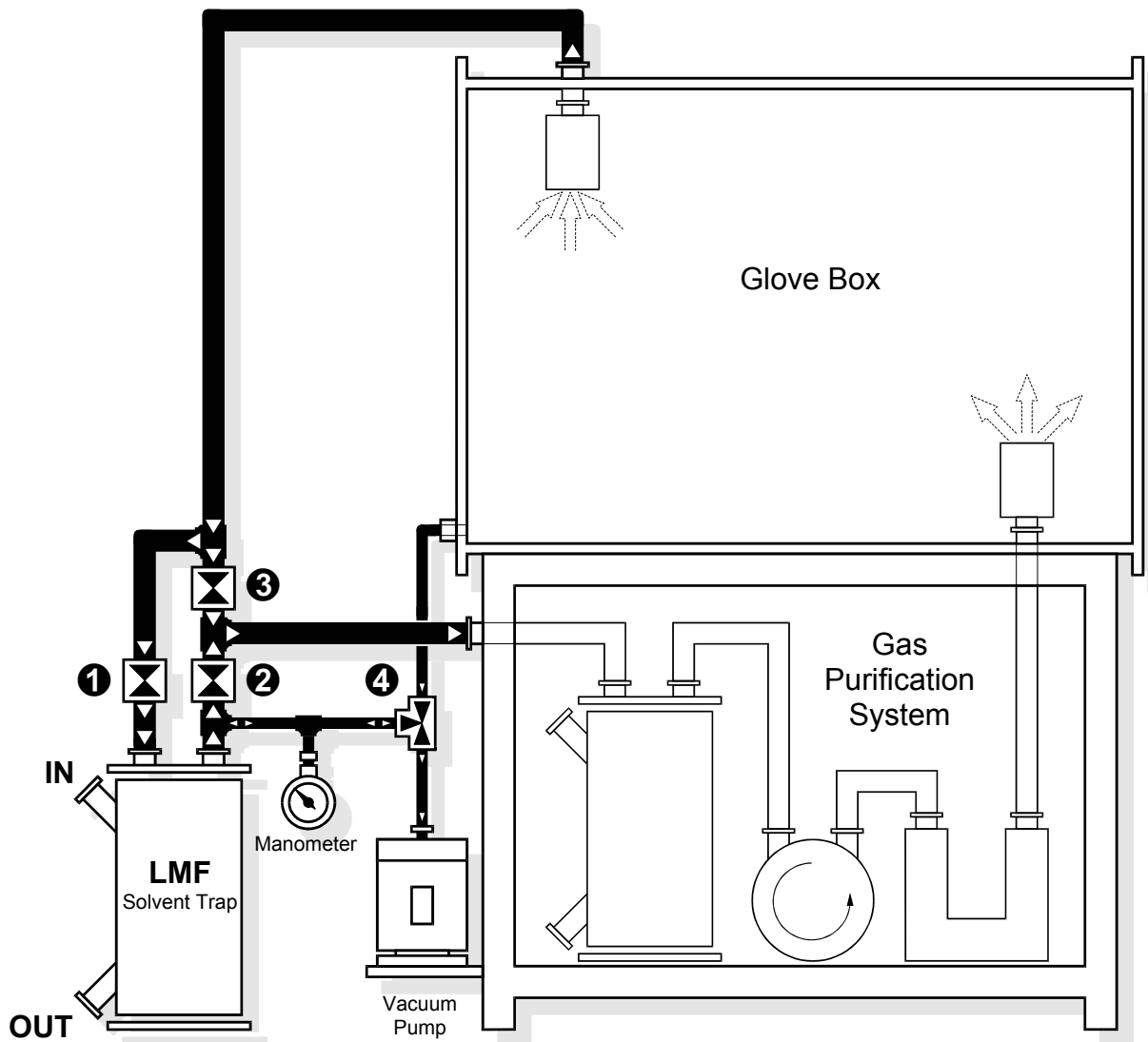

Figure 2: Operation of Solvent Trap

MB LMF-II: OPERATION MODE

Operation: Gas purification system (GPS)
and solvent absorber (LMF)

Open valve ①

Open valve ②

Close valve ③

Valve ④ position "CLOSED"

MB LMF-II: BYPASS MODE

Operation: Gas purification system (GPS)
without solvent absorber (LMF)

Open valve ③

Close valve ①

Close valve ②

Valve ④ position "CLOSED"

11.2.1. Changing the Filter Medium

Note:

MBRAUN recommends that the Solvent trap medium is changed at least annually. However, in cases of high solvent uses this may need to be more frequent.

1 kg of charcoal can adsorb approximately 100 g organic solvents. However, the exact quantity depends on the type of the solvent and the ambient conditions - in particular the ambient temperature. **MBRAUN** offers an optional solvent sensor. This sensor monitors the solvent concentration in the gas flow leaving the solvent filter, there by giving an prompt warning of saturation of the filter.

Warning:

Using a system with a saturated solvent filter can lead to a damage of O-rings, the copper pipework and other components of the gas purification as well as of the glove box system. It may result in actual loss of the gas impermeability for the overall glovebox system.

Caution:

Wear protective mask, glasses and gloves whilst changing the activated carbon.

Safe operation of the system is only possible with activated carbon, obtainable from **MBRAUN**. (article no. 2182000)



1. Switch the gas purification system into the bypass mode by setting the valves in the following positions:

Open valve ③

Close valve ①

Close valve ②

Valve ④ - position "CLOSED"

2. Open outlet flange (OUT) at the solvent absorber (LMF) and empty the exhausted carbon in a tub. Please dispose the exhausted activated carbon correctly – observing all applicable environmental, safety and health guidelines.
3. After the emptying the trap close the outlet flange (OUT) and open the inlet flange (IN) at the solvent absorber (LMF).
4. Fill in new activated carbon; filling amount 5 kg. Afterwards close the inlet flange (IN) again.
5. Set hand valve ④ on "EVACUATE" position. The minimum duration of the evacuation is 6 hours.
6. After the evacuation set the hand valve ④ on "REFILL" position. Wait until the pressure indication at the manometer (MM) has reached the value "0".
7. After the refilling set the hand valve ④ on "CLOSED" position. The solvent absorber (LMF) is again ready for operation.

11.3. PLC Controlled Solvent trap

11.3.1. Status of Solvent Trap (LMF) Filters

The Status of the Filters can be seen at all times on the start screen. The Icon for the filter differs for each mode. As show in figure 3.

Figure 3: Status of Purifiers

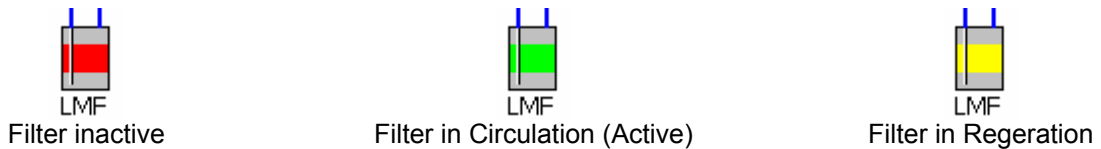

Note:

The principle for circulation is the same for both 1 and 2 filter systems.
 The two filter system allows greater flexibility in operation of the box by allowing one filter to be regenerated whilst the other is in circulation (purifying) Mode.
 The position of buttons is shown for the Touch Panel (TP170B). However the principle for operation is the same for the TOUCH Panel series. Only those buttons relevant to the system supplied are displayed.

11.3.2. Activating and Deactivating the Solvent Trap Mode

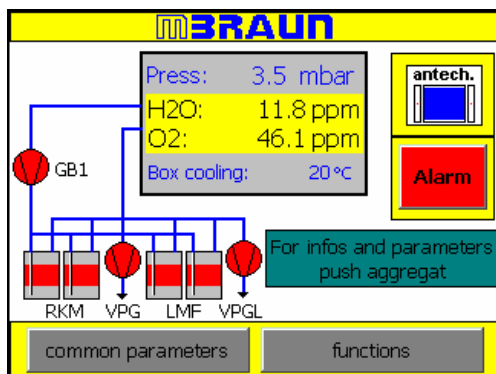

Select the Functions button on the Start screen.

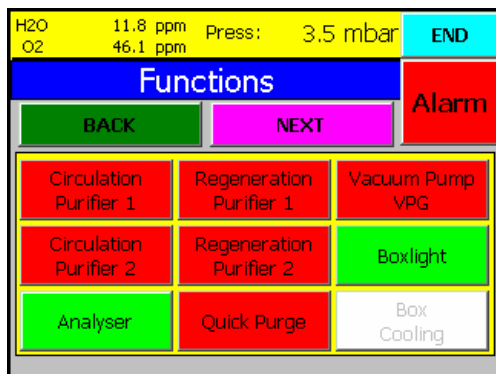

Select the Circulation Purifier button (red) to start the circulation over one of the purifier filters (RKM)

(see circulation Mode for further information.)

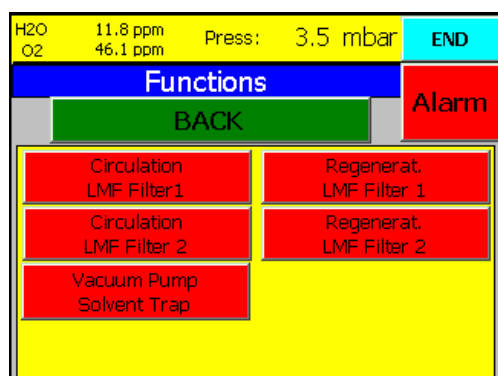

Select the Next button until the Function screen for the Solvent Trap (LMF) appears.

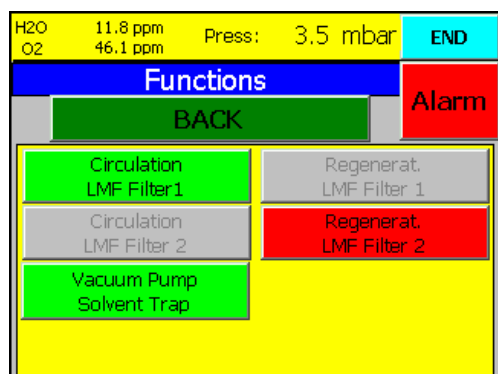

To acknowledge that the purifier is in Circulation Mode the button will change to green.

Note:

The Vacuum Pump activates automatically, if not previously activated.

The regeneration function for the selected filter will become blocked (button will display grey) until Circulation of the filter is cancelled.

Note:

If the system has a second filter option this will have its circulation function blocked. Regeneration of second filter is still available.

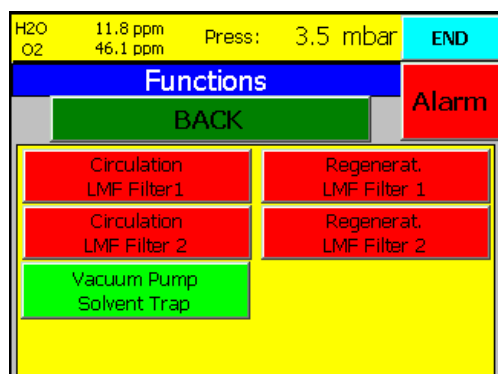

Selecting the Circulation Filter button a further time will switch off the circulation over the first purifier column.

Note:

The Vacuum Pump remains activated until it is deactivated by selecting its function button.

11.3.3. Regeneration of the Solvent Trap

The principle for regeneration of the solvent trap is the same as for the H₂O/O₂ gas purification system (see also chapter Regeneration.)

Note:

Systems that are equipped with one solvent trap are fitted with a by-pass valve to allow the filter to be regenerated whilst the system operates over the H₂O/O₂ gas purification system.

11.4. Solvent Vapour Analyzer

The solvent vapour analyser is available as an option.

Access to the solvent trap analyzer screen is made by selecting the "Icon" button for the LMF on the "Start Screen and then further selecting the "Parameters" button.

Solvent Trap		Analyzer	
Status	BACK	END	Alarm
Solvent Trap Analyzer			
Actual value analyzer :	1.4	V	
Alarm setpoint analyzer :	5.0	V	

The solvent vapour analyzer reading is proportional to the concentration of the solvent vapour after passage over the solvent trap.

The sensitivity of the solvent vapour analyser depends upon the type of solvent being handled. Therefore the reading returned to the control panel is in the form of a voltage measurement (between 0V and 10V).

The **MBRAUN** solvent vapour analyser can be calibrated for a specific solvent upon request.

Note:

The Alarm setpoint Analyzer setting will differ for various solvents.

Blank Page

Contents

12.	Glove Box Parameter Settings	2
	General Information.....	2
	Status Overview	2
12.A.	Setting the Box Pressure	4
12.A.1.	Freezer / Box Cooling Parameters	5
12.B.	Gas Purification System (RKM)	6
12.B.1.	Parameters for Gas Purification System.....	6
12.B.1.1.	Status of Gas Purification System.....	6
12.B.2.	Functions for Gas Purification System.....	7
12.C.	Solvent Vapour Filter Purification System (LMF)	8
12.C.1.	Parameters for Solvent Vapour Filter	8
12.C.1.1.	Status of Solvent Vapour Filter.....	8
12.C.2.	Functions for Solvent Vapour Filter	9
12.D.	Common Parameters	10
	Layout of Parameter Screens	10
12.D.1.	Alarm Setpoints.....	11
12.D.2.	H ₂ O / O ₂ Min/Max Values	11
12.D.3.	Purifier Operating Hours	12
12.D.4.	Purifier Trends	12
12.D.5.	System Settings	13
12.D.5.1.	Date and Time	13
12.D.5.2.	Touch Calibration	13
12.D.5.3.	Screen Cleaning	14
12.D.5.4.	Language.....	14
12.D.5.5.	WIN CE.....	14
12.D.5.6.	Info.....	14
12.D.5.7.	LOGIN / LOGOUT	14
12.D.6.	Service Functions	15
12.D.7.	Box Purging Parameters.....	15
12.D.8.	Freezer / Box Cooling Parameters	15
12.E.	Functions	16
12.F.	Warnings and Error Messages	17
12.G.	Antechamber Functions	18

12. Glove Box Parameter Settings

General Information

On the TP170B Operation Panel (*TOUCH* Screen) display all messages, values and parameters of the system can be displayed.

The manufacturer for optimum operation of the system has set the parameters. If required, the user may change them.

Status Overview

When the system is activated the TP170B Touch Screen will display the “Start Screen”. This screen displays an overview of the system and reports reading for various sensors. (See diagram below).

Figure 1: Start Screen

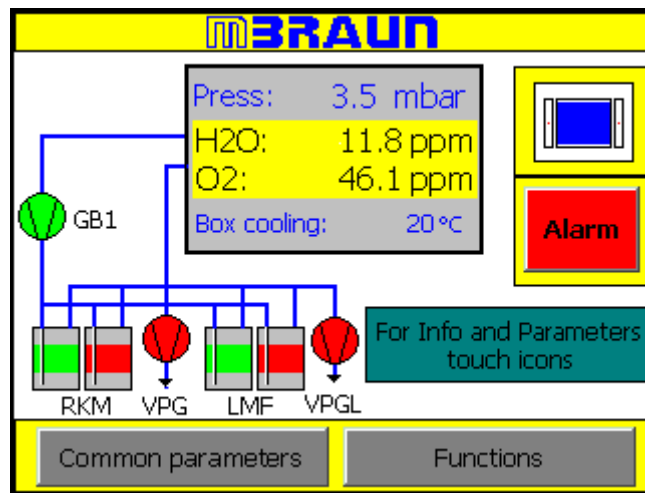

In the upper display area of the message level current operating values are permanently displayed, such as the box pulse.

The diagram below shows how each screen may be accessed. Each screen is numbered and are described further in the following sections:

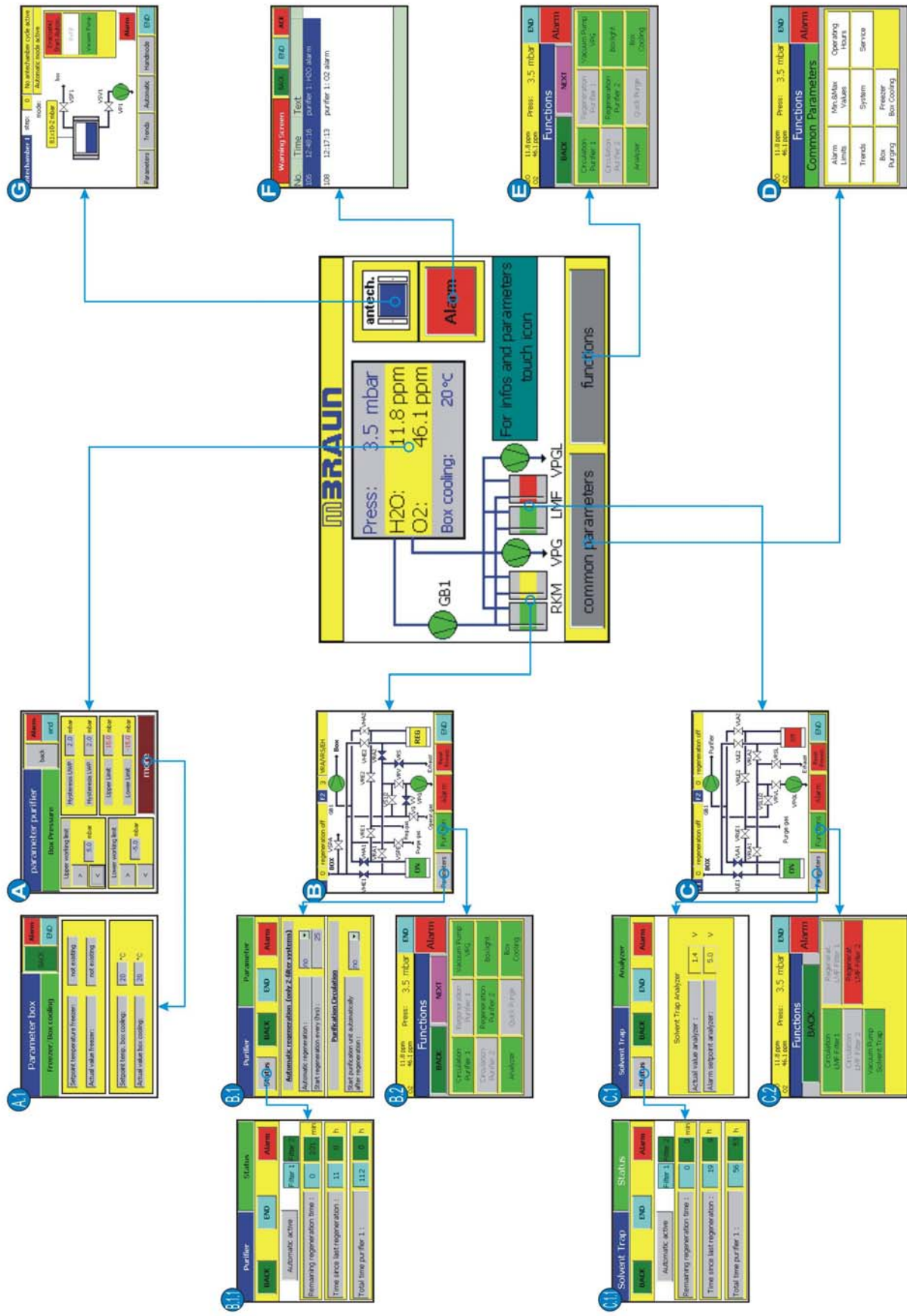

12.A. Setting the Box Pressure

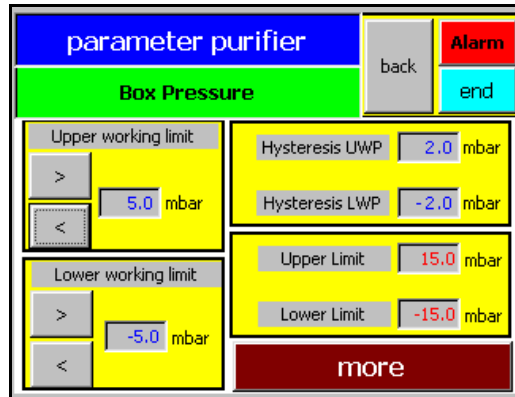

When this display selected, the box pressure control is deactivated.

You can enter the upper and lower working limit directly via the arrow-buttons “>” and “<” or by selecting the numeric box and then entering the value with the alpha/numeric keypad.

The upper working limit cannot be set higher than the upper limit, and likewise the lower working limit cannot be set lower than the lower limit.

How the box pressure control works is visible in the chart shown below.

If the working limit is exceeded or the pressure falls below the lower limit, evacuation takes place for a short time or gas is refilled, until the pressure falls within the working limit of the value of the adjusted hysteresis. The hysteresis for the upper and the lower limit can be set independently from each other.

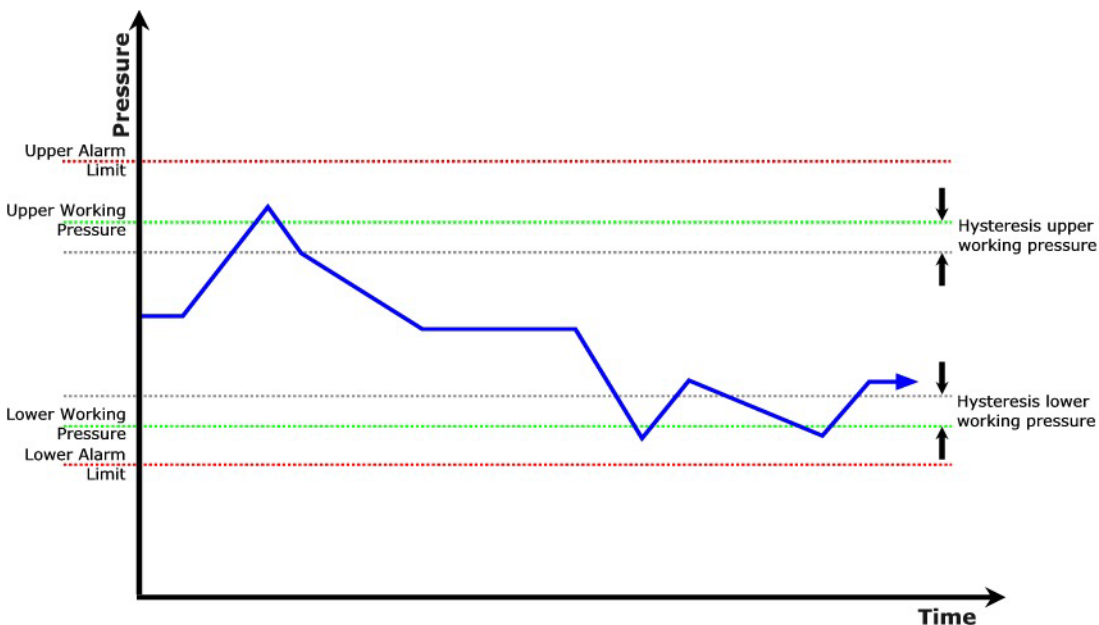

12.A.1. Freezer / Box Cooling Parameters

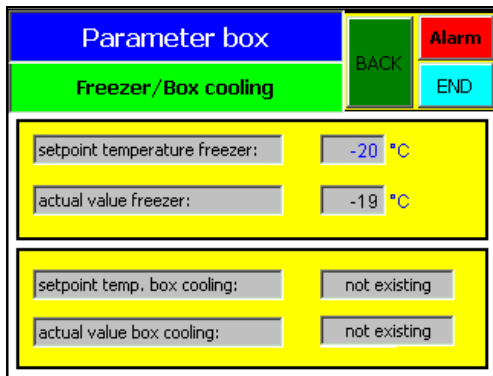

The Freezer and Box Cooling functions are offered as an option.

The use and setting for the Freezer and Box Cooling are described in their individual chapters.

12.B. Gas Purification System (RKM)

Note:
See also “Circulation” and “Regeneration” Chapters.

The screens below show how the gas purification system screens may be navigated and a brief description of the data that is displayed on each screen. For further information on the principles of the gas purification system see also the Circulation and Regeneration chapters.

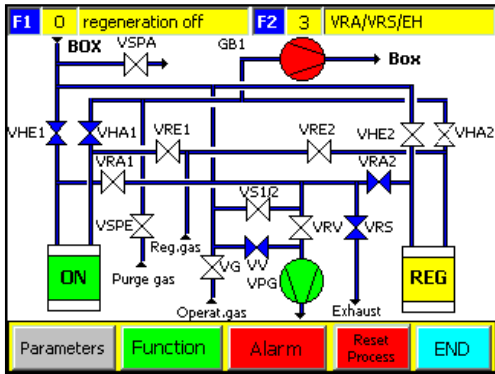

The screen left shows the function status of the gas purification system (RKM).

The top line gives the “regeneration step” and valve status for the regeneration process for each RKM filter.

The main screen displays the gas purification system as a schematic diagram.

At the bottom of the screen are buttons for navigating to further screens.

12.B.1. Parameters for Gas Purification System

Purifier	Parameter
Status	BACK END Alarm
Automatic regeneration (only 2-filter systems)	
Automatic regeneration :	no
Start regeneration every (hrs) :	25
Purification Circulation	
Start purification unit automatically after regeneration :	no

The screen displays the parameters for the gas purifier (RKM) automatic regeneration.

The options and parameters are entered by selecting the input fields to the right of the screen.

12.B.1.1. Status of Gas Purification System

Purifier	Status
BACK	END Alarm
Automatic active	Filter 1 Filter 2
Remaining regeneration time :	0 201 min
Time since last regeneration :	11 0 h
Total time purifier 1 :	112 0 h

This screen displays the time status for the gas purifiers (RKM).

The numeric values are system generated.

The total time purifier is the time, since insulation, that the purifier has been in active service. This figure would only be reset in the event of M.Braun service technicians replacing the filter medium.

12.B.2. Functions for Gas Purification System

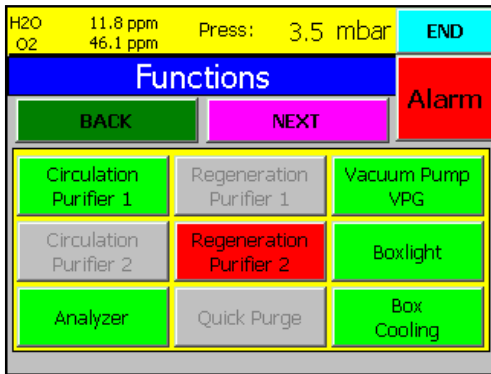

Function buttons for the gas purification system and glove box.

Note:

Systems fitted with dual filter solvent filters (LMF Auto) require circulation over one of the solvent filters (LMF) whenever the gas purification (LMF) circulation is used.

12.C. Solvent Vapour Filter Purification System (LMF)

Note:

See also “Circulation” and “Regeneration” Chapters.

The screens below show how the solvent filter screens may be navigated and a brief description of the data that is displayed on each screen. For further information on the principles of the solvent filter see also the Circulation, Regeneration and Solvent Filter chapters.

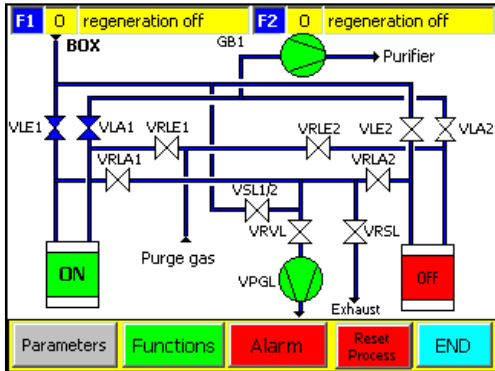

The screen left shows the function status of the solvent filter (LMF).

The top line gives the “regeneration step” and valve status for the regeneration process for each LMF filter.

The main screen displays the solvent filter system as a schematic diagram.

At the bottom of the screen are buttons for navigating to further screens.

12.C.1. Parameters for Solvent Vapour Filter

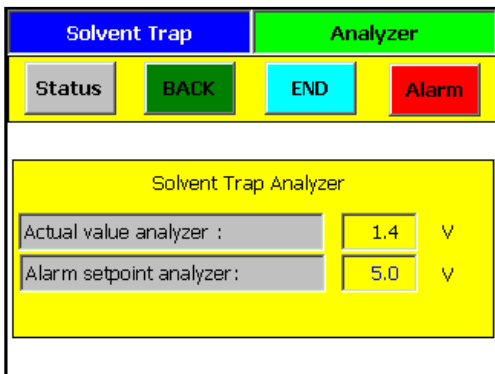

The screen displays the alarm parameters for the solvent filter (LMF).

For further details see Solvent Filter chapter.

12.C.1.1. Status of Solvent Vapour Filter

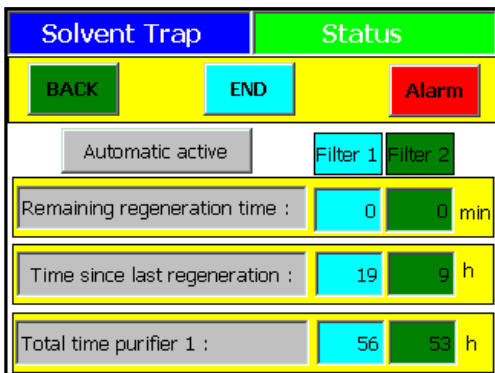

This screen displays the time status for the solvent filters (LMF).

The numeric values are system generated.

The total time purifier is the time, since insulation, that the purifier has been in active service. This figure would only be reset in the event of M.Braun service technicians replacing the filter medium.

12.C.2. Functions for Solvent Vapour Filter

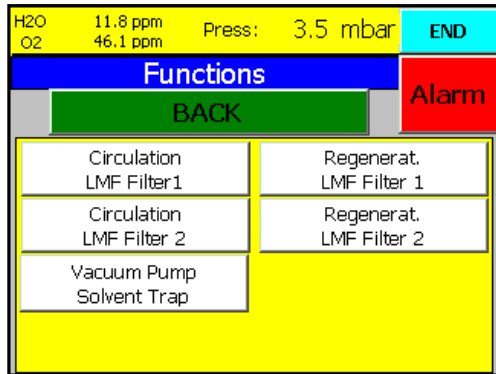

Function buttons for the solvent filter system.

Note:

Systems fitted with dual filter solvent filters (LMF Auto) require circulation over one of the solvent filters (LMF) whenever the gas purification (LMF) circulation is used.

12.D. Common Parameters

Layout of Parameter Screens

Below is an overview of the screens that may be accessed from the Common Parameters screen. Each purpose and function of each numbered screen is explained in the following section.

H2O O2	11.8 ppm 46.1 ppm	Press: 3.5 mbar	END
Functions			Alarm
Common Parameters			
Alarm Limits	Min.&Max Values	Operating Hours	
Trends	System	Service	
Box Purging	Freezer Box Cooling		

D.1

H2O O2	11.8 ppm 46.1 ppm	Press: 3.5 mbar	Alarm
Alarm setpoints			END
H2O alarm: 20.0 ppm			BACK
O2 alarm: 20.0 ppm			
temperature alarm freezer: not existing			
temperature alarm box cooling: not existing			

D.2

H2O O2	11.8 ppm 46.1 ppm	Press: 3.5 mbar	Alarm
H2O/O2: Min/Max Values			END
RESET			
H2O max: 15.9 ppm min: 5.7 ppm			
O2 max: 75.2 ppm min: 1.6 ppm			

D.3

Parameter purifier		BACK	Alarm
Operating hours			
Vacuum pump VPG:	89	h	
Blower GB1:	71	h	
Compressor box cooling:	0	h	
Compressor freezer:	0	h	
Vacuum pump VP1:	0	h	
Vacuum pump VP2:	0	h	
Vacuum pump VPGL:	0	h	

D.4

Trends Purifier		BACK	END	Alarm
H2O	O2	BoxPress		
<<	>>	Zoom +	Zoom -	<

D.5

System		BACK	END	Alarm
Touch calibration				
Screen cleaning	date: 12/31/2000			
Language	time: 11:59:51 PM			
Info				
WIN CE	LOGIN	LOGOUT	Password	

D.6

H2O O2	11.8 ppm 56.1 ppm	off off	Press: 3.5 mbar	End
functions				
LOGIN				
Password: <input type="text"/>				
OK		Cancel		
Box purging	Info			

D.7

parameter purifier		back	Alarm
Box purging			
automatically purging with O2 limit value violation:	no	v	
oxygen limit value:	0	ppm	
automatically purging with box pressure alarm:	no	v	

D.8

Parameter box		BACK	Alarm
Freezer/Box cooling			
Setpoint temperature freezer:	not existing		
Actual value freezer:	not existing		
Setpoint temp. box cooling:	200	°C	
Actual value box cooling:	0	°C	

12.D.1. Alarm Setpoints

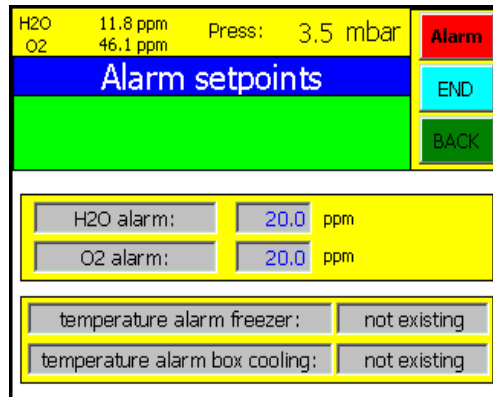

Gas Purification Alarm limits may be entered by selecting the numeric field and then by using the alpha/numeric keypad. As soon as the limits are exceeded a message is issued.

12.D.2. H2O / O2 Min/Max Values

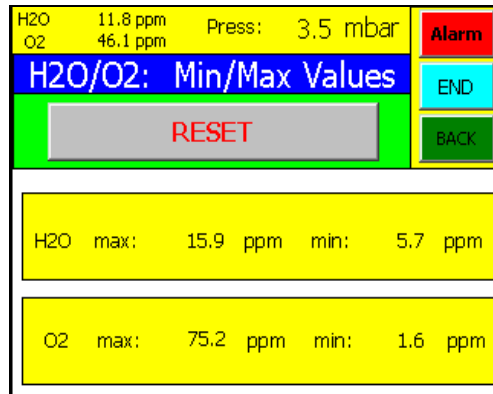

This display shows the highest and lowest measured gas readings for the box atmosphere. The RESET button will clear these values and save the current value set until the atmosphere has altered to a new high or low and then that reading will be stored.

12.D.3. Purifier Operating Hours

Information regarding the total operation time of the system components can be seen on the “Operating Hours” Screen.

Note:

See also section “Status of Purifier Filters” in “Circulation” Chapter.
 See also section “Status of Regeneration” in “Regeneration” Chapter.

Parameter purifier		BACK	Alarm
Operating hours		BACK	END
Vacuum pump VPG:	89 h		
Blower GB1:	71 h		
Compressor box cooling:	0 h		
Compressor freezer:	0 h		
Vacuum pump VP1:	0 h		
Vacuum pump VP2:	0 h		
Vacuum pump VPGL:	0 h		

Information displayed is the total amount of hours that the components have been in use.

Note:

The times can only be reset by MBRAUN Service personnel e.g. upon replacement of a spare part by MBRAUN Service Technicians.

12.D.4. Purifier Trends

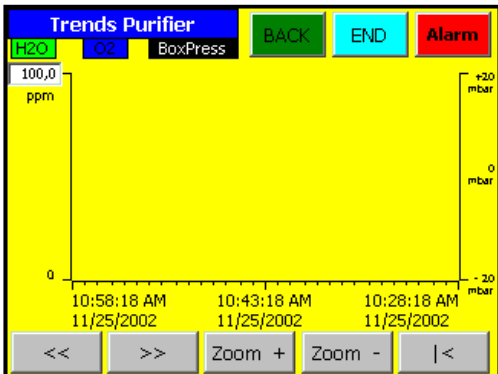

The trends screen is in the form of a time graph.

There are 5 buttons on all graph displays. With the **back<<**, **forward>>** you can move along the time axis. With the **Zoom+** and **Zoom-** you can select a narrower or broader time frame. The **|<** button returns you to the current time.

The Y-axis may be calibrated between 50 and 1000 ppm by selecting the input field shown on the axis.

The smallest time frame for the X-axis is 1 minute.

12.D.5. System Settings

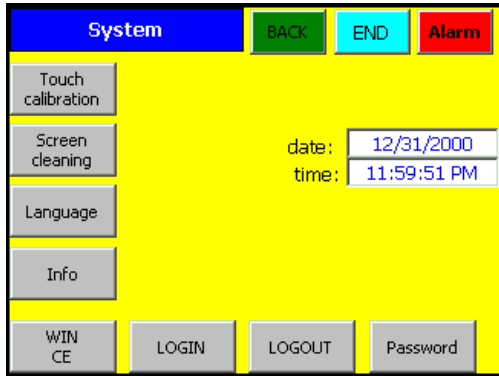

To access the “System Settings” screen select the “Common Parameters” from the “Start Screen”, and then select “System”.

12.D.5.1. Date and Time



The Date and time may be set to local setting by the customer.

To change the time, follow directing in section “Input Fields and Buttons” in Chapter “Operation Panel TOUCHpanel (TP170b).”

12.D.5.2. Touch Calibration

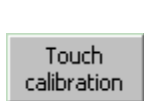

Purpose:

Depending on the fitting position as well as the viewing angle the touch screen may need to be calibrated to avoid any operating errors. You can calibrate the screen by selecting the **Touch Calibration** button.

Procedure:

Start the calibrating procedure via the Touch Calibrating pushbutton. Five calibration crosses are displayed in succession at random points on the screen. Follow the instructions displayed on the screen and touch each calibration cross as it is displayed.

Performing calibration

With the calibration procedure completed, touch the screen at any point for accepting the latest calibration data.

Rejecting calibration

Wait for 30 seconds, until the overlaid timer-bar has reached zero, for rejecting the latest calibration data. In case calibration has been carried out incorrectly the latest values are not accepted.

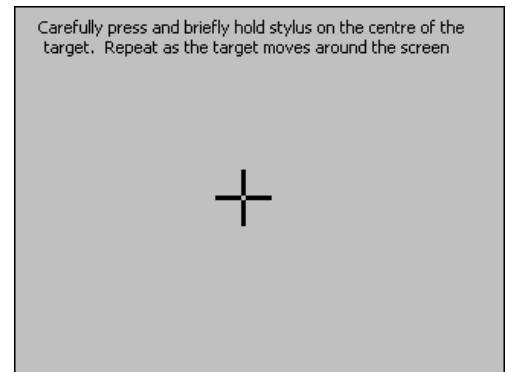

12.D.5.3. Screen Cleaning

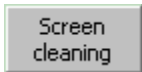

After cleaning display has been started, all inputs via the touch screen are locked for 30 seconds. A run bar indicates the remaining time.

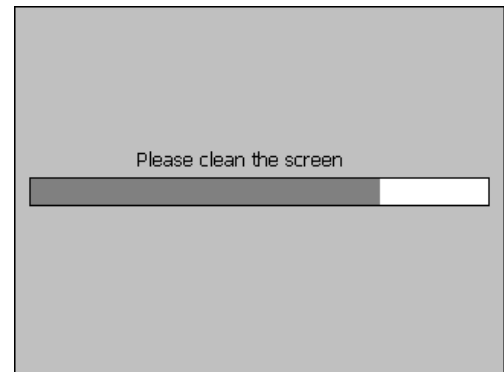

Protective foil

For the Touch-Screen a protective foil is available. However this protective foil is not included in delivery of the TP170.

The self-adhesive protective foil protects the screen against scratches and grime.

In addition, the matt surface of the foil reduces any kind of reflection.

If required the protective foil can be removed at any time without leaving residual glue on the screen. If required a new foil would need to be applied.

Caution

For removing the protective foil do not use any sharp or pointed objects, such as knives, which may result in damage to Touch Screen.

12.D.5.4. Language

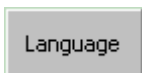

The Touch Operation Panel (TP170b) enables the user to select between preloaded languages.

MBRAUN systems are currently loaded with German and English. To change between languages stored on the TP170 simply press the "Language" button.

12.D.5.5. WIN CE

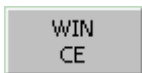

With the Win CE button activated, the Run-time program is completed and the panel is run down to the operating system level. If important filing procedures are running in the background, this is the safest way of completing the filing procedures before the device is deactivated.

12.D.5.6. Info

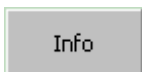

This area displays the following information:

- Type of device, project number, manufacturer's address.

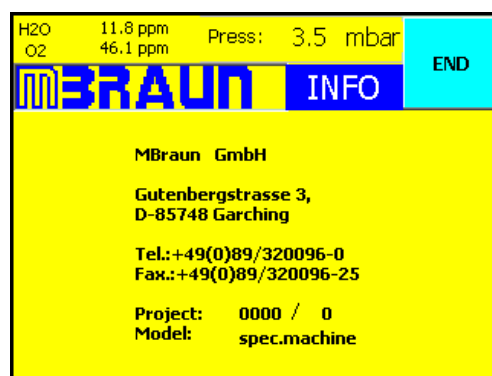

12.D.5.7. LOGIN / LOGOUT



These Buttons are reserved for service use only.

Selecting the "LOGOUT" button will log the user out of the current "Password" level. That is the password level will be set to "zero".

12.D.6. Service Functions



The "Service" button

Note:
The Service Function is password protected. It is reserved for MBRAUN service personnel only.

No Operating instructions are given for the service function. Information about the settings within the service mode is reserved for MBRAUN Service personnel only.

12.D.7. Box Purging Parameters

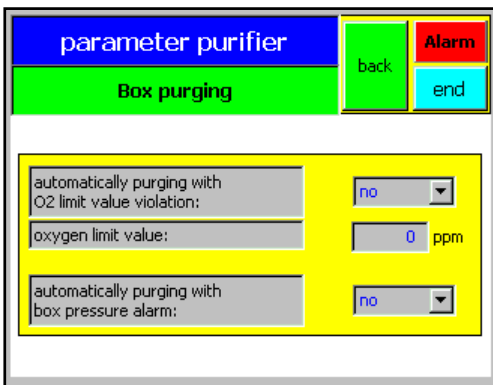

Two types of automatic purging options are available on the screen.

The purging methods are selected by choosing either yes or no in the relevant input field on the right of the screen.

Automatically purging with O2 limit value violation – will purge the glove box atmosphere as soon as the **Oxygen limit value** is over stepped
e.g. if the oxygen limit value is 50 ppm and the sensor reading is 51 ppm then the Automatic purging will bring the oxygen content of the glove box atmosphere to below 50 ppm.

Automatically purging with box pressure alarm – will either refill or evacuate the glove box by 5 mbar if the box pressure alarm setpoint is overstepped.

e.g. A system is required to be used with an under pressure and the pressure upper pressure alarm parameter is set at -1mbar. If the pressure increases above -1mbar then the box atmosphere will be evacuated by 5 mbar bringing the pressure down to -6mbar.

Like wise if the under pressure setpoint is over stepped then the glove box will be filled by 5 mbar.

12.D.8. Freezer / Box Cooling Parameters

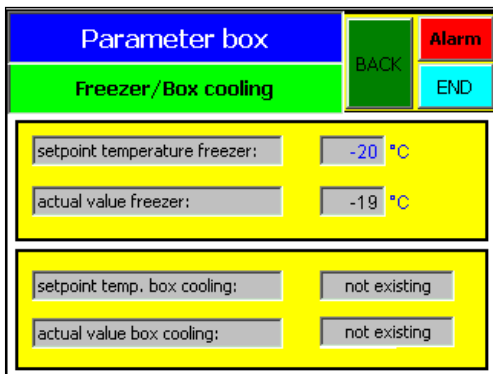

The Freezer and Box Cooling functions are offered as an option.

The use and setting for the Freezer and Box Cooling are described in their individual chapters.

12.E. Functions

Note:

Via the Functions button in the Start Display, all existing functions can be selected and the status can be controlled. The individual displays comprise the functions in the form of buttons so that these functions are selectable within the individual function groups.

Below are the normal function screens showing the location of all the common function buttons.

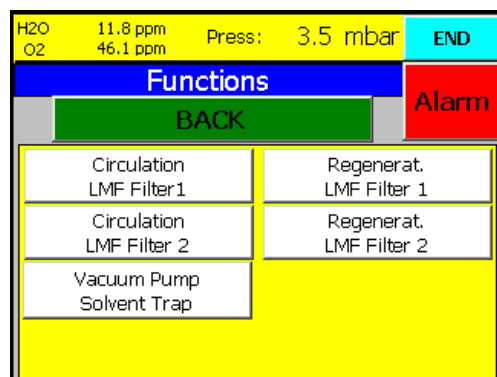
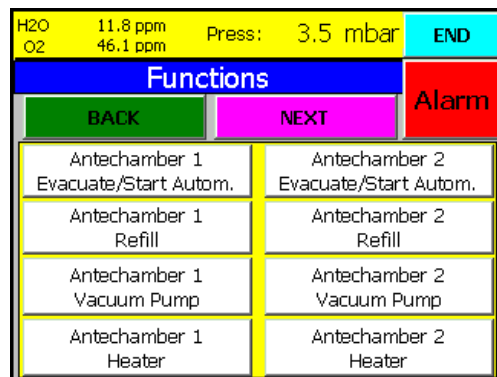
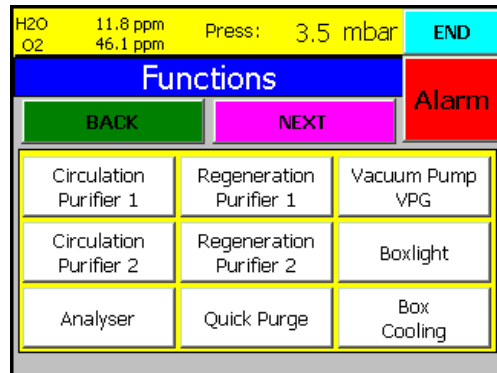

12.F. Warnings and Error Messages



The "Alarm" Button appears in each screen.

On occurrence of a fault or an error the "Alarm" button will flash. To view the error messages, push the "Alarm" button. This will open the Warnings Screen.

Figure 2: Warning Screen

Warning Screen			BACK	END	ACK
No.	Time	Text			
106	12:48:16	purifier 1: H2O alarm			
108	12:17:13	purifier 1: O2 alarm			

The messages that appear in the screen are in order of occurrence. The most recent message is the uppermost.



To acknowledge that a message has been read, select the message by touching the screen. The message will become highlighted on the screen. Select the Acknowledge button.

Messages that are no longer valid (e.g. The moisture sensor reading is again within the alarm limit range) will be removed from the screen upon being acknowledged.

Selecting the "Back" button will return to the previous screen.

12.G. Antechamber Functions

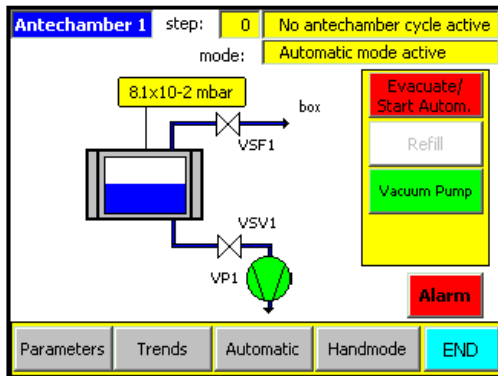

The purpose and functions of the antechamber are described in the chapter – Antechamber Operation.

Contents

13.1.	General Information	2
13.2.	Principle	2
13.3.	Overview	3
13.3.1.	Handmode (Standard) Antechamber Operation	3
13.3.2.	Automatic Antechamber Control	3
13.4.	Important Notes.....	3
13.5.	Transferring Material into the Box	4
13.5.1.	Preparation	4
13.5.2.	Evacuation in Manual Mode	4
13.5.3.	Refilling in Manual Mode	5
13.6.	Information About the Automatic Antechamber Control.....	6
13.7.	Antechamber Parameters.....	7
13.7.1.	Parameter Definitions.....	7
13.8.	Trends for Antechamber	8
13.9.	Transferring Material Out of the Box	9
13.9.1.	Preparation	9
13.9.2.	Removal of Material from Antechamber.....	9
13.10.	Circular Antechambers.....	10
13.10.1.	Opening and Closing the Antechamber Door Outside the Box.....	10
13.10.2.	Opening and Closing the Antechamber Door Inside the Box.....	11
13.11.	Mini Antechamber	12
13.11.1.	Opening and Closing the Outer Door	12
13.11.2.	Transferring Material Out of the Box	14
	<u>Table of Figures</u>	
	<i>Figure 1: Principle of Antechamber Operation</i>	<i>2</i>
	<i>Figure 2: Antechamber Control Screens</i>	<i>3</i>
	<i>Figure 3: Principle of Automation Antechamber Cycles</i>	<i>6</i>

13.1. General Information

Antechambers are designed for transferring material into or out of the inert Glove Box System without polluting the box internal atmosphere during the respective procedures.

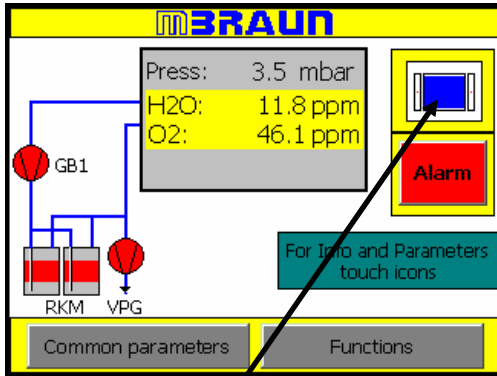

Antechamber Icon shown on Start Screen

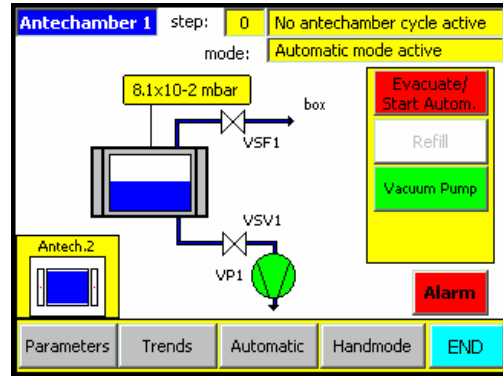

Antechamber Screen
(Button for 2nd antechamber is also shown)

13.2. Principle

Figure 1: Principle of Antechamber Operation

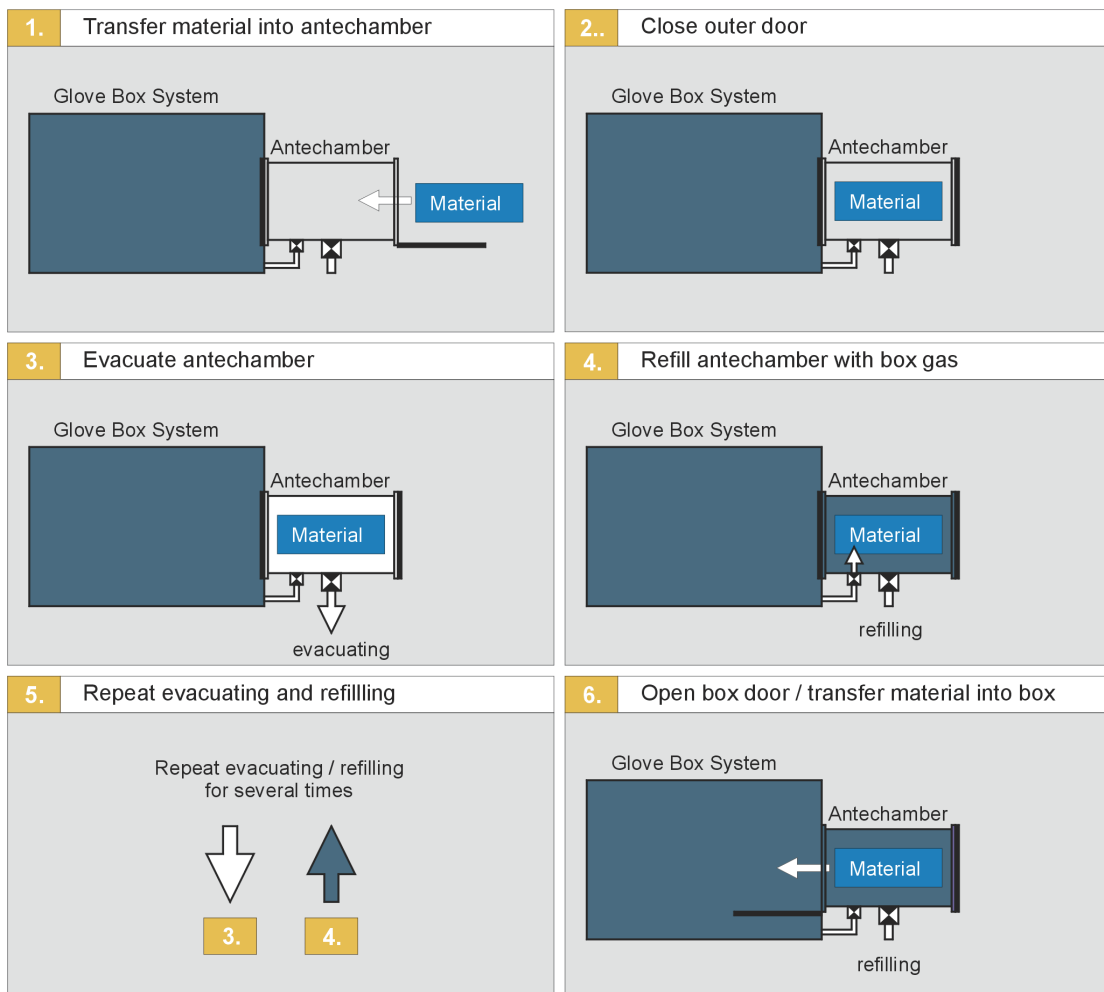

13.3. Overview

Figure 2: Antechamber Control Screens

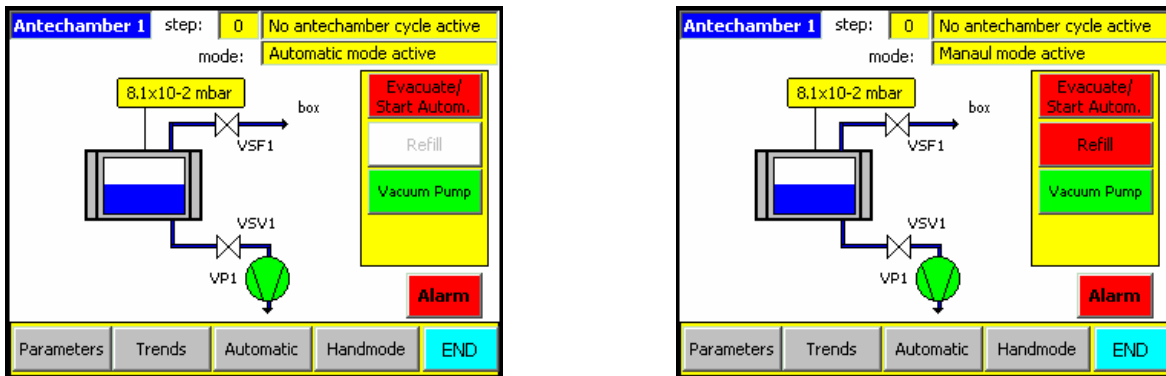

Antechamber in Automatic Mode

Antechamber in Handmode

13.3.1. Handmode (Standard) Antechamber Operation

Handmode operation means that the functions of “Antechamber Evacuation” and “Antechamber Refilling” should be started and completed manually.

13.3.2. Automatic Antechamber Control

The automatic antechamber control is a control software option. With this program available the evacuating/refilling cycles are automatically executed and controlled.

Recommendation:
 MBRAUN recommends the use of Automatic Antechamber Operation, if available

13.4. Important Notes

The pressure within the antechamber may be given by:

- A manometer mounted onto the antechamber, and/or
- A pressure reading being displayed within the antechamber screen (Yellow box above antechamber Icon)

Caution:
 Never open box and outer antechamber doors simultaneously.
 An evacuated antechamber cannot be opened.
 Attempting to open an evacuated antechamber may damage the door locking mechanism. Never open a box door of an antechamber filled with ambient atmosphere. This would result in pollution of the box atmosphere and possibly in damage of measuring instruments and material within the box. Mechanical parts and seals should be checked regularly and protected against any contamination.
 When handling gases always keep to the national and international guidelines.

Recommendation:
 If the system is equipped with a separate pump, MBRAUN recommends that the pump is switched off (using the control panel) when not required. The pump will be restarted automatically on the next evacuation/refill cycle.

13.5. Transferring Material into the Box

Note:

Applies to systems without optional automatic antechamber control.

13.5.1. Preparation

- Observe Item “Important Notes” in this chapter.
- The antechamber door located inside the box is closed.
- The outer antechamber door is open.
- If a sliding tray is available: Pull out sliding tray; lay material on tray; then slide the tray together with the material into antechamber.
- If no sliding tray is available: Transfer the material directly into antechamber.
- Then close outer antechamber door.

Caution:

If you transfer material with enclosed gaseous volume into the box the material should be able to withstand the pressure difference during the antechamber purge process (evacuation and refilling cycles). If possible open up any seals to enclosed gaseous volume – e.g. lids of bottles – so that the enclosed gases will also be exchanged during the pump/fill cycle.

13.5.2. Evacuation in Manual Mode

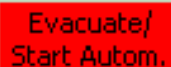

Press the Evacuate/Start Autom button to start evacuation.

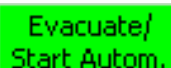

The antechamber is being evacuated. Status indicator of the “Evacuate/Start Autom” button is green, an appropriate status message appears at the top of the Antechamber screen and the “Blue Bar” in the antechamber icon will decrease to show current status.

Recommendation:

MBRAUN recommends an evacuation of the antechamber up to a value of <math><0.5\text{ mbar}</math>.

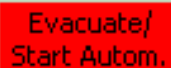

Pressing the “Evacuate/Start Autom” button again will stop the process.

13.5.3. Refilling in Manual Mode

A red rectangular button with the word "Refill" in white text.

Press the "Refill" button to start refilling the antechamber.

A green rectangular button with the word "Refill" in black text.

The antechamber is being refilled with gas from the box atmosphere. Status indicator of the "Refill" button is green, an appropriate status message appears at the top of the Antechamber screen and the "Blue Bar" in the antechamber icon will increase to show current status.

Note:

Refill antechamber until pressure compensation between glove box and antechamber is attained.

A red rectangular button with the word "Refill" in white text.

Pressing the "Refill" button again will close the valve between the antechamber and the box.

Caution:

For obtaining a high degree of purity, the antechamber should undergo repeated evacuation and refilling procedures.

In this case for intermediate refilling a pressure of approximately 200 mbar is sufficient. The last refilling step always has to be back to box pressure.

13.6. Information About the Automatic Antechamber Control

Note:
Applies only to systems equipped with an optional automatic antechamber control.

Figure 3: Principle of Automation Antechamber Cycles

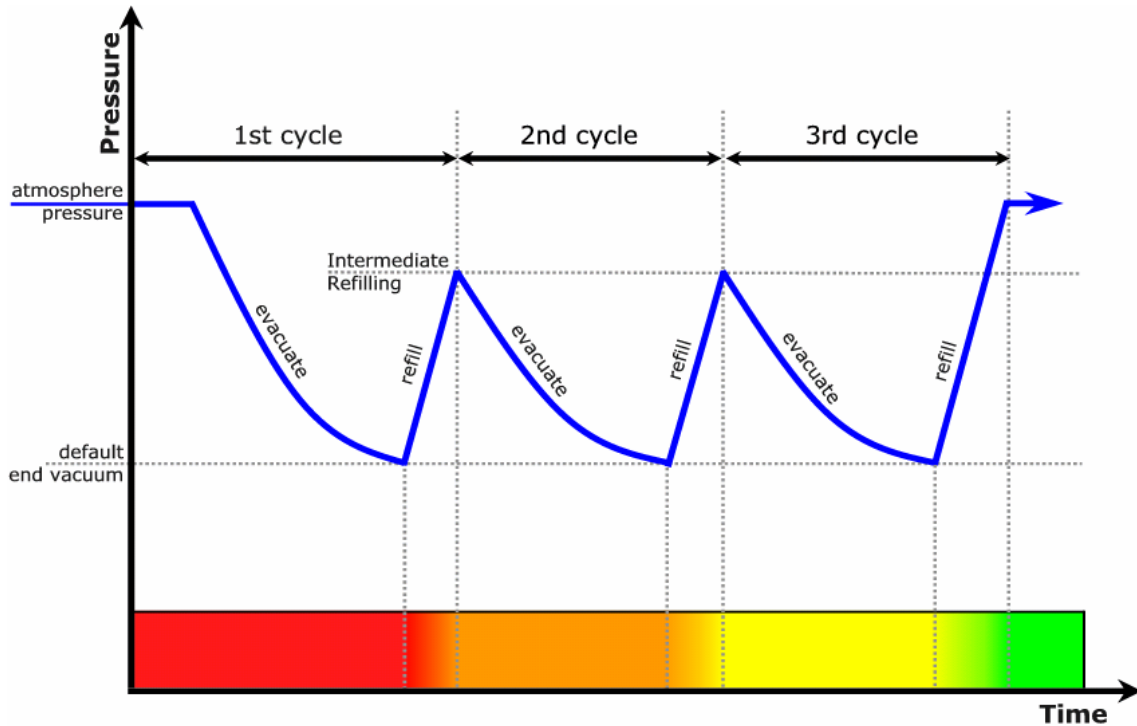

The diagram above shows how the intermediate refilling affects the atmosphere within the antechamber.

The parameters of the automatic antechamber control have optimally been matched with the antechamber by the manufacturer. If required, they can be changed by the user. For information about changing the parameters refer to “Antechamber Parameters” Section.

Evacuate/
Start Autom.

Press the Evacuate/Start Autom button to start Automatic evacuation.

Evacuate/
Start Autom.

The antechamber is being evacuated.

Evacuate/
Start Autom.

The “Evacuate/Start Autom” button will release when the process has finished.

13.7. Antechamber Parameters

Selecting the Parameters button from the “Antechamber” screen will open the parameters screen.

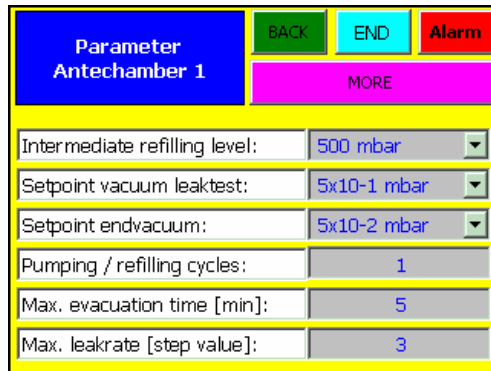

13.7.1. Parameter Definitions

Intermediate refilling Level: Up to this value the oven is flooded with inert gas.

Setpoint vacuum leaktest: At this pressure the vacuum leaktest will be started.

Setpoint endvacuum: Up to this pressure the antechamber will be evacuated.

Pumping/refilling cycles: Number of evacuation and refilling cycles.

Max. evacuating time [min]: If the set value “setpoint vacuum leaktest” is not reached in this time the automatic antechamber cycle will be stopped and the warning: “pumping time exceeded” will be displayed

Max. leakrate [step value]: Parameter of the maximum pressure increase during the 2 steps of the vacuum leaktest within the measuring time frame.
 Example: 2x10⁻¹ mbar to 4x10⁻¹ mbar.
 If the parameter value is exceeded the antechamber process will be stopped and the warning: “antechamber leaking” will be displayed.

13.8. Trends for Antechamber



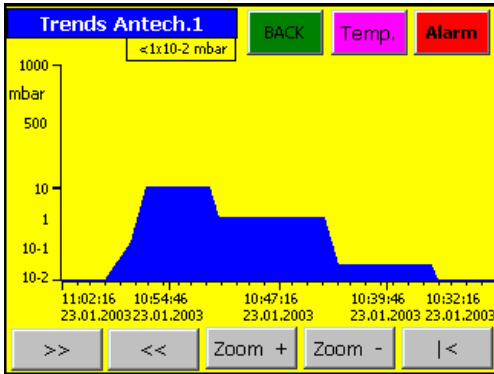

All graphs are similarly designed. The measurements are displayed on a time-line graph.

The trend graph for the antechamber is accessed by selecting the “Trends” button in the “Antechamber” screen.



The first trends screen displays the atmosphere pressure within the antechamber.

The current atmosphere pressure is displayed at the top left-hand corner of the screen.

There are 5 buttons on all graph displays. With the  (back) and  (forward) buttons you can move along the time axis. With the  and  (zoom) buttons you can select a narrower or broader time frame. The  (re-set) button returns you to the current time.

- X - Axis = Timescale – details in hours and minutes
- Y - Axis = Measurement in mbar (pressure) or °C (temperature)

13.9. Transferring Material Out of the Box

13.9.1. Preparation

- Observe Item “Important Notes” in this chapter.
- The outer antechamber door is closed.
- The antechamber door located inside the box is open.
- If a sliding tray is available: Pull out sliding tray; lay material on tray; then slide the tray together with the material into antechamber.
- If no sliding tray is available: Transfer the material directly into antechamber.
- Then close inner antechamber door.

13.9.2. Removal of Material from Antechamber

- Open the antechamber door located outside the box.
- If a sliding tray is available: Pull out sliding tray; remove material from tray; then slide the tray back into antechamber.
- If no sliding tray is available: Transfer the material directly out of the antechamber.
- Then close the outer antechamber door.

Caution:

Annoyance by bad smell is expected as soon as any waste purge gas is escaping to the surroundings. Environmental pollution and effects detrimental to health, however, are not known, but cannot be excluded. The manufacturer does not assume any liability. When using toxic or radioactive material manual, by no means the gas should escape to the environment. Information about pertinent alternative methods: service@mbraun.de

Recommendation:

Ensure that both outer and inner doors of the antechamber are closed when material is not being transferred through the antechamber. After having the outer antechamber door opened, it is recommended that at least one evacuation and refill cycle is completed for the antechamber to prevent possible condensation being deposited on the interior antechamber walls.

13.10. Circular Antechambers

13.10.1. Opening and Closing the Antechamber Door Outside the Box

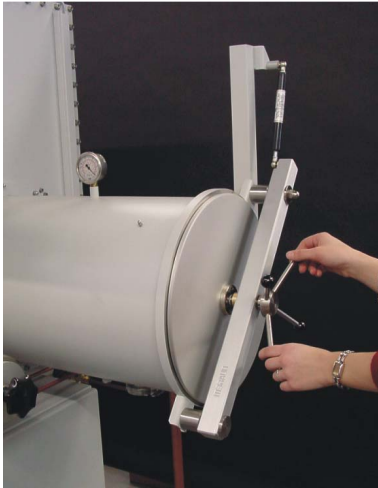

Observe all items of this chapter.
Turn the locking mechanism until the antechamber door is free.

Caution:

Antechamber under vacuum cannot be opened. If you try to open the antechamber under vacuum the opening mechanism can be damaged.

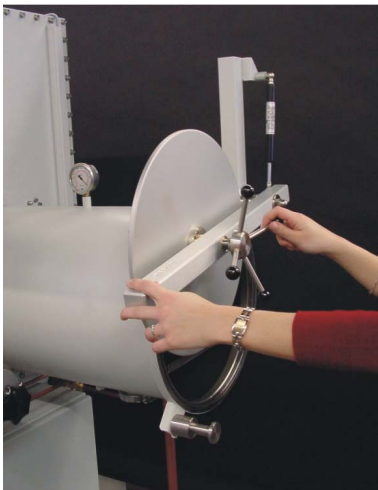

Carefully open the antechamber door in upward direction.



The antechamber door is held by the spring mechanism. It stays in the position (see picture).

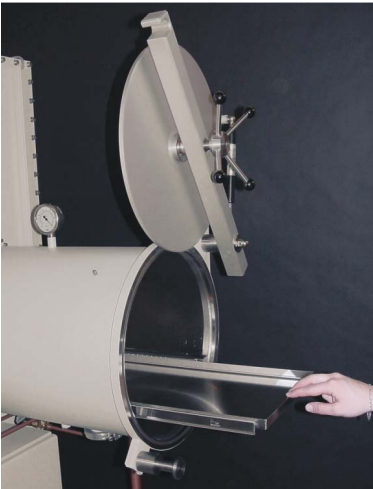

Carefully pull out sliding tray.

Closing the outer door is done in reverse order.

13.10.2. Opening and Closing the Antechamber Door Inside the Box



After execution of the evacuation/refill cycles: Opening and closing of the antechamber door inside the box is done in the same way as described for the outer door.

Caution:

By no means open the inner door of an antechamber filled with air. This will result in polluting the inert box atmosphere and possibly in damaging measuring instruments and any material. Antechamber under vacuum cannot be opened. If you try to open the antechamber under vacuum the opening mechanism can be damaged.

13.11. Mini Antechamber

13.11.1. Opening and Closing the Outer Door



Observe all items of this chapter.
Turn the locking mechanism until the cover is free.

Caution

Antechamber under vacuum cannot be opened. If you try to open the antechamber under vacuum the opening mechanism can be damaged.



Remove the cover.



Insert material into the antechamber.



Put the cover back on (please pay attention to the slide-ways) and turn the locking mechanism to close it.



Execution of the evacuation/refill cycles:

- A. Turn the hand valve to the position "Evacuate". The antechamber will be evacuated.



- B. Evacuate until the manometer shows a pressure of -0.9 up to -1.0 bar.



- C. Turn the hand-valve to the position "refill". Please pay attention to the description on the antechamber. The antechamber is purged with box gas. Purge until there is a pressure balance between the box and the antechamber. The reading on the manometer will change to zero.



Please process the described work cycle (Points A-C) at least twice, then the hand valve can be turned to the position "close".

Caution:

By no means open the inner door of an antechamber filled with air. This will result in polluting the inert box atmosphere and possibly in damaging measuring instruments and any material.



Turn the locking mechanism until the cover is free.



Remove the cover and take the material out of the antechamber.

13.11.2. Transferring Material Out of the Box



Insert the material into the antechamber. Put the cover back on (please pay attention to the slide-ways) and turn the locking mechanism to close it.

Caution:

Annoyance by bad smell is expected as soon as any waste purge gas is escaping to the surroundings. Environmental pollution and effects detrimental to health, however, are not known, but cannot be excluded. The manufacturer does not assume any liability. When using toxic or radioactive material manual, by no means the gas should escape to the environment.

Information about pertinent alternative methods:
service@mbraun.de



Remove the outer cover and the material.

Contents

14.1. General Information2

14.2. Operation of the Oven2

14.3. Parameters for Oven Antechamber.....3

 14.3.1. Parameter Definitions3

14.4. Trends for Oven Antechamber4

14.1. General Information

M.Braun glove boxes can be equipped with an oven. The oven can be installed at the place usually occupied by the antechamber, or as an additional antechamber on the opposite side, the rear ore on top of the glove box.

The oven allows a process at an elevated temperature to be performed under vacuum and/or under an inert gas atmosphere. Typical applications are for the removal of water or solvents from either surfaces or substances prior to the material being transferred into the glove box.

If the oven is placed at the side of the glove box then it typically functions as an antechamber, i.e. it allows the transfer of materials into and out of the inert Glove Box System without polluting the box internal atmosphere during the respective procedures.

Note:

See also Antechamber chapter.

The Oven antechamber has a slightly larger diameter and longer length than the standard antechamber to allow for the heating and cooling apparatus whilst maintaining similar internal dimension as a standard antechamber.

M.Braun also offers a range of ovens for specific operations.

14.2. Operation of the Oven

See also “Antechamber Operation” Chapter.

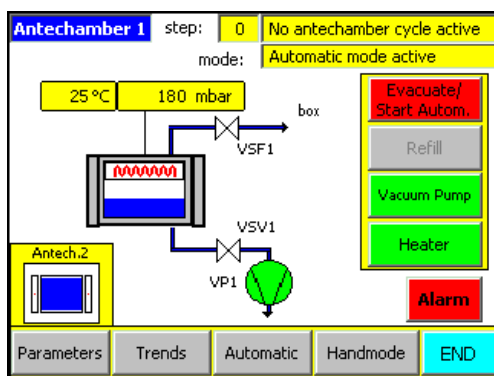

The picture shows the schematic structure of the oven antechamber. The yellow status fields display the various actual values or process steps.

In the section to the right of the screen are the oven functions.

At the bottom of the screen are buttons for operation mode and status button. Selecting the appropriate button will open the “Oven Parameters” screen or the “Trends” Screen.

Note:

Operation of the antechamber is possible with or without the heating cycle. Selecting the “Heating” button switches the heating function.

14.3. Parameters for Oven Antechamber

Selecting the Parameters button from the “Antechamber” screen will open the parameters screen. The parameters that are specific for the oven operation are accessed by pressing the “more” button.

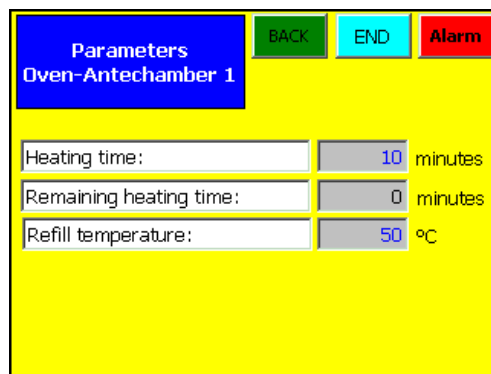
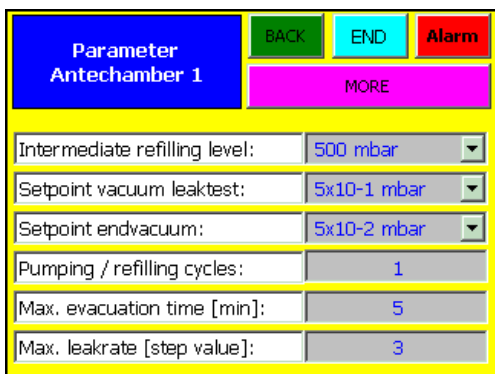

14.3.1. Parameter Definitions

Intermediate refilling Level: Up to this value the oven is flooded with inert gas.

Setpoint vacuum leaktest: At this pressure the vacuum leaktest will be started.

Setpoint endvacuum: Up to this pressure the antechamber will be evacuated.

Pumping/refilling cycles: Number of evacuation and refilling cycles.

Max. evacuating time [min]: If the set value “setpoint vacuum leaktest” is not reached in this time the automatic antechamber cycle will be stopped and the warning: “pumping time exceeded” will be displayed

Max. leakrate [step value]: Parameter of the maximum pressure increase during the 2 steps of the vacuum leaktest within the measuring time frame.
 Example: 2×10^{-1} mbar to 4×10^{-1} mbar.
 If the parameter value is exceeded the antechamber process will be stopped and the warning: “antechamber leaking” will be displayed.

Heating time: The maximum time that is allowed for the oven to reach the desired temperature.

Refill temperature: The oven must cool to this level after the heating process, following this it may be flooded with inert gas to the atmospheric pressure.

Note:
 Heating time and Refill temperature parameters when the system is equipped with the automatic cycle function

14.4. Trends for Oven Antechamber

All graphs are similarly designed. The measurements are displayed on a time-line graph.

The trend graphs for the oven antechamber are displayed over two screens and are accessed by selecting the “Trends” button in the “Antechamber” screen.

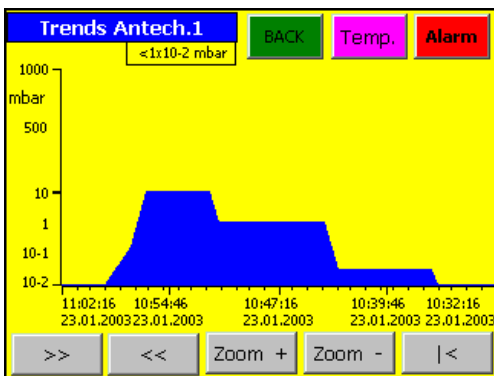

The first trends screen displays the atmosphere pressure within the antechamber.



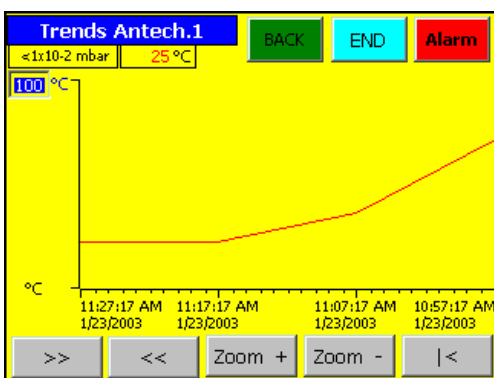

The current atmosphere pressure is displayed at the top left-hand corner of the screen.



The second “Trends” screen displays the temperature within the antechamber.

On the left-hand side of the screen is an input field that allows the Y-axis scale to be altered between the range of 1°C and 800°C.

The current atmosphere pressure and temperature are displayed at the top left-hand corner of the screen.

There are 5 buttons on all graph displays. With the  (back) and  (forward) buttons you can move along the time axis. With the  and  (zoom) buttons you can select a narrower or broader time frame. The  (re-set) button returns you to the current time.

- X - Axis = Timescale – details in hours and minutes
- Y - Axis = Measurement in mbar (pressure) or °C (temperature)

Contents

15.1. General Information	2
15.1.1. Connection Diagram.....	3
15.1.2. Activating the Analyser(s).....	4
15.1.3. Deactivating the Analyser(s)	4
15.2. Calibration of Sensors	5
15.3. Oxygen Analyser (MB OX-SE-1)	5
15.3.1. General.....	5
15.3.2. Construction	5
15.3.3. Connector	6
15.3.4. Technical Data	6
15.3.5. Installation	7
15.3.6. Trouble-shooting	7
15.4. Oxygen Analyser (MB OX-SE-3)	8
15.4.1. General Information.....	8
15.4.2. Description	8
15.4.3. Technical Data	8
15.5. Moisture Analyser (MB MO-SE-1).....	9
15.5.1. General.....	9
15.5.2. Technical Data	9
15.5.3. Connector	10
15.5.4. Trouble Shooting	10
15.5.5. Maintenance: Sensor Cleaning	10
 <i>Table of Figures</i>	
<i>Figure 1: Types of Sensor</i>	<i>2</i>
<i>Figure 2: Connection Diagram.....</i>	<i>3</i>
<i>Figure 3: Procedure for Cleaning Moisture Sensor</i>	<i>11</i>

15.1. General Information

Note:

Applies to systems with optional H₂O and/or O₂ analysers. Systems with analyser option are equipped with an “Analyser” function button. The measured H₂O and/or O₂ values are shown on the operation panel display.

Not all analysers are necessarily included as selected options.

Figure 1: Types of Sensor



MB-OX-SE-1



MB-OX-SE-3



MB-MO-SE-1

15.1.1. Connection Diagram

Figure 2: Connection Diagram

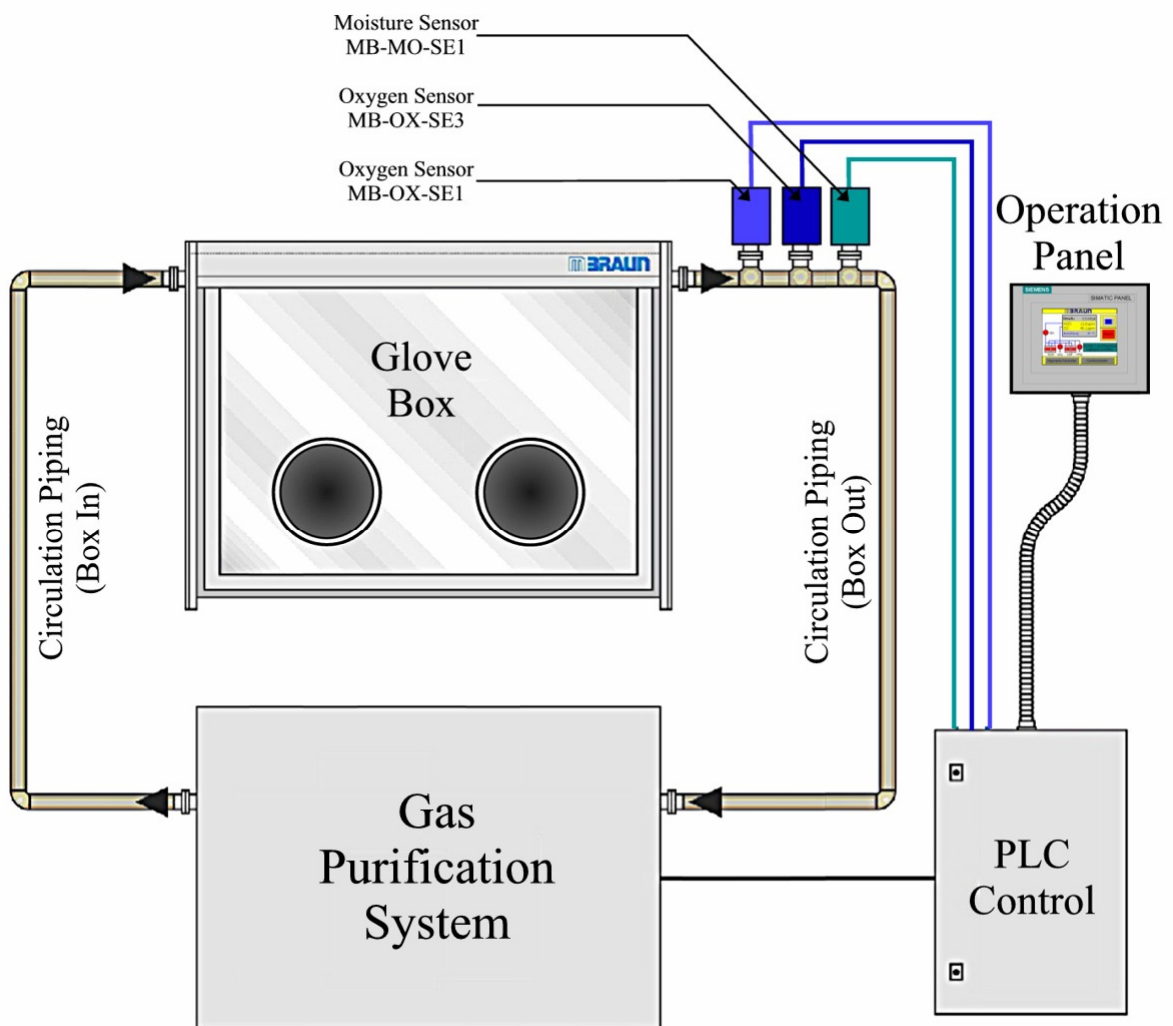

15.1.2. Activating the Analyser(s)

Note
 High levels of ambient atmosphere within the box could damage or pollute the measuring instruments, the box atmosphere and any materials within the box. Ensure that the antechamber atmosphere has been purged, as required, before opening the inner antechamber door.
 Do not open both doors of an antechamber at the same time causing the ambient atmosphere to enter the box.

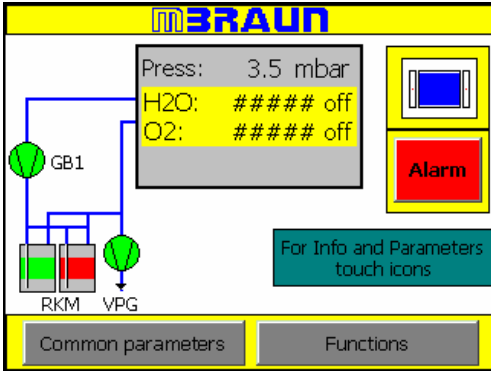

Start display with the analysers switched off.

To activate the analysers, open the Functions screen by selecting the “Function” button.

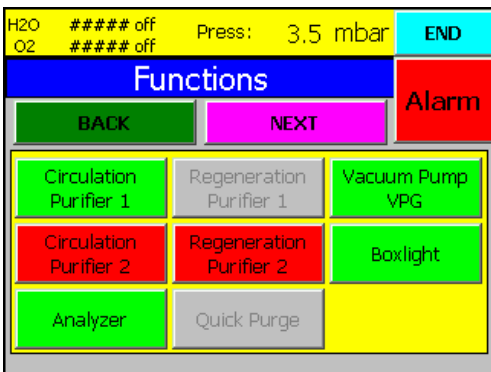

Selecting the “Analyser” button will activate the connected analysers.



The button will display the status change by changing from red (not active) to green (active).

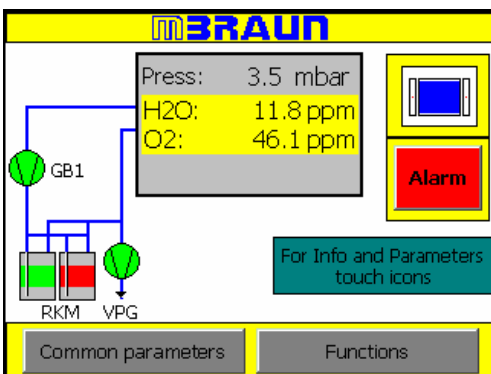

The reading from the analysers can now be seen on the start screen. The readings are also repeated on various other screens.

The analyser readings are in the following format:

Press: xxx Pa
H2O*: xxx ppm
O2:** xxx ppm
Box Cooling*:** xxx °C

* Is displayed only when the system is provided with a moisture analyser.
 ** is displayed only when the system is provided with an oxygen analyser.
 *** is displayed only when the system is provided with cooling.

15.1.3. Deactivating the Analyser(s)

Deactivating the Analysers is carried out by the same procedure as activation.



The Analyser button will display the status change by changing from green (active) to red (not active).

15.2. Calibration of Sensors

All **MBRAUN** sensors have a certified calibration before shipping.

Recommendation

MBRAUN recommends that sensors are calibrated annually by **MBRAUN** technicians.
Quotation on request from **MBRAUN** Service Department.

The calibration cycle depends on the demand for accuracy as well as on the conditions of the gas to be measured (purity, spurious gases etc.)

15.3. Oxygen Analyser (MB OX-SE-1)

15.3.1. General

The MB-OX-SE-1 sensor has been designed to control the atmosphere of **MBRAUN** Systems for residual Oxygen content. The measuring range is 0 to 1000 ppm. The measuring range from 0 – 100 ppm is linear. The measurement range is calibrated for use below 1000 ppm as the sensor output, above 100 ppm, not truly linear.

This probe can be used in particular for the control of a purge process – e.g. during the initial initialisation of a **MBRAUN** glove box system. The probe can be operated with PLC-systems, which are integrated in **MBRAUN** Systems as standard equipment, or with MB SSD-DIS monitors, which are available separately.

The use of the probe for other applications can be possible from case to case, however this has to be approved by **MBRAUN** first.

The semiconductor sensor made of Zirconium dioxide is specific for oxygen, but because of the high sensor temperature and the catalytic activity of the platinum coating of the sensor there are low cross-sensitivities for hydrogen as well as possible reactions with aggressive gaseous substances, that can reduce the operational life of the sensor.

Caution

Operating the sensor at oxygen levels of >1000 ppm (e.g. in air) does not irreversibly damage the sensor element, but it should be avoided. If exposed to air, it will take several hours until the sensor will measure low oxygen levels correctly in Inert Gas.

15.3.2. Construction

The MB-OX-SE1 consists of the sensor and the special electronics separated by a gas-tight NW40 clamp flange. The sensor is protected against physical damage by a protective cage. The sensor leads are connected to the electronics by vacuum-tight feed-throughs. The electronics are contained in an airtight box mounted directly to the back of the NW40 flange.

The measuring electronics is operated by 24 VDC. It supplies a 0 to 10 VDC output proportional to the oxygen concentration. An additional input switches the heating element of the sensor on and off to control the temperature of the sensor. If this input is not used, an internal jumper has to be set to operate the probe.

Electronics and Sensor Element have been factory-calibrated with certified calibration gases; there are no user-accessible adjustment points.

The electronics and the sensor are calibrated with NIST traceable gases.



Warning:

The probe may not be used in flammable or explosive gas atmospheres (measured gas or outside environment).

It lies within the responsibility of the user to ensure, that flammable or explosive gas mixtures cannot be exposed to the sensor head during operation.

(At the discretion of **MBRAUN GmbH**, a calibration procedure can be supplied, for trained technicians to recalibrate the sensor's low range, 0-100ppm)

15.3.3. Connector

Connector

8-pole socket (RJ45):

Pin-No.	Contact
1	Supply Ground
2	Switching ON/OFF 24 V
3	Signal Ground
4	Livebit (O ₂)
5	Not Connected
6	Signal 0 - +10 V
7	Supply +24 V
8	Supply Ground

15.3.4. Technical Data

Mechanical

Length over all: 190 mm, height 80 mm, depth 58 mm

Sensor-part: length 45 mm, diameter 26 mm

Flange: NW 40 KF

Weight: 0.7 kg

ElectricalSupply voltage: 24 VDC \pm 10%

Protection class: IP 53

Environment

Ambient temperature: +15 to +27 °C

Pressure: 800 to 1200 mbar (Differential pressure sensor to electronics max. \approx 100 mbar)Volumetric flow-rate: 100 l/h (\pm 10%)**Measuring**

Range: 0 - 1000 ppm oxygen

Sensitivity: 10 mV / ppm

Response time (0 - 90 %): approximately 10 sec (0 - 90 %)

Warm-up time: 10 min (for < 10 ppm approx. 6 hr)

Accuracy¹⁾: 2 % of displayed value \pm 1 ppm up to 100 ppm

Drift at 10 ppm: 10 % / year

Sensor life²⁾: ca. 5 yearsCross sensitivities³⁾ Gaseous, oxygen-containing compounds can lead to an apparent oxygen signal.

1) In a clean inert gas atmosphere, without interfering, cross sensitive or reactive gases.

2) In absence of reactive gases (like halogenated hydrocarbons, halogens, other halogen containing gases or vapours, sulphur dioxide, hydrogen sulphide, silanes, hydrogen). Contact [MBRAUN](#) Service for further advice.3) In particular: oxygen containing hydrocarbons with a high vapour pressure (Ethanol, Diethyl ether) carbon monoxide, carbon dioxide, nitrogen dioxide, sulphur dioxide. After extended operation in an oxygen free environment there will be a cross sensitivity towards water vapour. The cross sensitivities named lead mostly to a very weak additional signal that can be tolerated. Contact [MBRAUN](#) Service for further advice.

15.3.5. Installation

Caution

Before applying electrical power the sensor should be exposed to clean inert atmosphere for at least 1 minute.

The oxygen probe is mounted vacuum-tight on an appropriate NW40 flange by means of a centring ring and a clamp. The usual way is to use a NW40 t-piece in the gas flow piping. This will guarantee that the sensor is exposed to direct gas-flow and is not located in a dead space. The sensor only requires a low flow rate and is not flow sensitive up to flow rates of 2 m/s.

The plug connection to the control unit must not be made before the whole box-system has been purged sufficiently with inert gas.

The operation of the probe as well as the display of the measured values is performed by the control unit.

15.3.6. Trouble-shooting

The oxygen probe does not contain user-serviceable parts. Therefore in case of defects the probe has to be sent complete and unopened to **MBRAUN** or the authorized representative. On request **MBRAUN** may offer exchange probes.

Description of malfunction	What to do
The display measuring value comes very slowly below 10 ppm, whereas it is certain that the real value is much lower (Check, whether this is really the case or the display is correct).	The sensor is still charged with oxygen by a previous operation at high oxygen concentrations or long storage in air. In this case operate the sensor for some hours in clean inert atmosphere and it will come down. The sensor has a very stable zero-point, so before sending the probe for repair you must exclude the possibility that e.g. hydrogen in ppm-levels is present or was present in higher levels.

15.4. Oxygen Analyser (MB OX-SE-3)

15.4.1. General Information

The oxygen probe MB OX-SE-3 serves to monitor the amount of oxygen in an inert gas atmosphere (nitrogen, argon or helium) of a **MBRAUN** glove box system. The probe has a wide range from 0 to 25 vol% of oxygen concentrations. Therefore this probe can be used in particular for the control of a purge process – e.g. during the initial initialisation of a **MBRAUN** glove box system. The probe can be operated with PLC-systems, which are integrated in **MBRAUN** Systems as standard equipment, or with MB SSD-DIS monitors, which are available separately.

The use of the probe for other applications can be possible from case to case, however this has to be approved by **MBRAUN** first.

15.4.2. Description

The oxygen probe MB OX-SE-3 comprises a sensor along with the electronics. The sensor-head is protected from external mechanical effects by means of a sturdy screw cap.

The sensor-head is a miniaturized Zirconium dioxide plate operated at elevated temperature, which is controlled by a platinum resistor. The electronics are supplied with 24 V DC and deliver a 0 - 10 V signal in proportion to the concentration of oxygen. An additional input for the electronics allows the switching on and off the sensor heating by means of the PLC or as the case may be the MB SSD-DIS monitor.

The electronics and the sensor are calibrated with NIST traceable gases.



Warning:

The probe may not be used in flammable or explosive gas atmospheres (measured gas or outside environment).

It lies within the responsibility of the user to ensure, that flammable or explosive gas mixtures cannot be exposed to the sensor head during operation..

15.4.3. Technical Data

Mechanical

Length over all:	190 mm, height 80 mm, depth 58 mm
Sensor-part:	length 45 mm, diameter 26 mm
Flange:	NW 40 KF
Weight:	0.7 kg

Electrical

Supply voltage:	24 V DC $\pm 10\%$
Protection class:	IP 53

Environment

Ambient temperature:	+15 to +27 °C
Pressure:	800 to 1200 mbar (Differential pressure sensor to electronics max. ≈ 100 mbar)
Volumetric flow-rate:	100 l/h ($\pm 10\%$)

Measuring

Range:	0 - 25 vol% oxygen
Sensitivity:	400 mV / %
Response time (0 - 90 %):	approximately 10 sec. (0 - 90 %)
Warm-up time:	10 min (for < 10 ppm approx. 6 hr)
Accuracy ¹⁾ :	< 1 % vol
Drift at 20.9 %vol:	0.5 % vol/24h
Sensor life ²⁾ :	ca. 5 years
Cross sensitivities ³⁾	Gaseous, oxygen-containing compounds can lead to an apparent oxygen signal.

1) In a clean inert gas atmosphere, without interfering, cross sensitive or reactive gases.

2) In absence of reactive gases (like halogenated hydrocarbons, halogens, other halogen containing gases or vapours, sulphur dioxide, hydrogen sulphide, silanes, hydrogen). Contact **MBRAUN** Service for further advice.

3) In particular: oxygen containing hydrocarbons with a high vapour pressure (Ethanol, Diethyl ether) carbon monoxide, carbon dioxide, nitrogen dioxide, sulphur dioxide. After extended operation in an oxygen free environment there will be a cross sensitivity towards water vapour. The cross sensitivities named lead mostly to a very weak additional signal that can be tolerated. Contact **MBRAUN** Service for further advice.

15.5. Moisture Analyser (MB MO-SE-1)

15.5.1. General

The MB-MO-SE1 has been designed to control the atmosphere of the **MBRAUN** Systems for residual moisture content. The measuring range is 0 to 500 ppm. The measuring range from 0 – 50 ppm is linear. The measurement range is calibrated for use below 500 ppm as the sensor output, above 50 ppm, is not truly linear.

The sensor element is a “double helix” made of platinum wire fixed on a special insulation material. The sensor is coated with phosphoric acid that is totally dehydrated. Water molecules in the gas penetrate the acid layer and the electrolysis of the resulting H^+ and OH^- ions to H_2 and O_2 produces an electric current. So, the water molecules coming to the sensor surface are removed and the resulting current is depending on the concentration of the water molecules in the gas. The primary signal is compensated for temperature and amplified.

15.5.2. Technical Data

Mechanical

Length over all: 205 mm, height 80 mm, depth 58 mm
 Sensor-part: length 42 mm, diameter 14 mm
 Flange: NW 40 KF
 Weight: 0.7 kg

Electrical

Supply voltage: 24 VDC $\pm 10\%$
 Protection class: IP 53

Environment

Ambient temperature: +15 to +27 °C
 Pressure: 800 to 1200 mbar (Differential pressure sensor to electronics max. ≈ 100 mbar)
 Volumetric flow-rate: 100 l/h ($\pm 10\%$)

Measuring

Range: 0 - 500 ppm moisture
 Sensitivity: 20 mV / ppm
 Response time (0 - 90 %): approximately 120 sec. (0 - 90 %)
 Warm-up time: 10 min (for < 10 ppm approx. 6 hr)
 Accuracy¹⁾:
 High precision range (0 - 10 ppm): better than 5 % of value
 Wide range (10 - 100 ppm): better than 20 % of value
 Drift at 10 ppm: 10% / year
 Sensor life²⁾: ca. 5 years

1) without interfering gases like NH_3
 2) with regular maintenance

15.5.3. Connector

8-pole socket (RJ45):

Pin-No.	Connection
1	Supply Ground
2	Switching ON/OFF 24 V
3	Signal Ground
4	Not Connected
5	Live bit (H ₂ O)
6	Signal 0 - +10 V
7	Supply +24 V
8	Supply Ground

15.5.4. Trouble Shooting

The oxygen probe does not contain user-serviceable parts. Therefore, in case of defects the probe has to be sent complete and unopened to **MBRAUN GmbH** or the authorized representative. On request, **MBRAUN** may offer exchange probes.

15.5.5. Maintenance: Sensor Cleaning

Recommendation:

MBRAUN recommends a maintenance cleaning procedure every 3 months.

Caution:

When cleaning the sensors it is important that contamination from the ambient atmosphere is prevented. Therefore **MBRAUN** recommends that the box parameters are set to a pressure of between +1.0 and +5.0 mbar (see parameters chapter) and that the circulation mode is switched OFF.

Note:

To achieve optimal moisture measurements the sensor is recommended to be closely inspected within a period of three months.

This routine maintenance consists in cleaning the platinum winding of the MB MO-SE-1 and moistening it with phosphorous acid H₃PO₄. The following aids are required for disassembling and maintaining the MB MO-SE-1.

Tool for disassembly (screwdriver)
 Soft, absorbent, lint free cloth (cotton)
 Small quantity of phosphorous acid (H₃PO₄).
 Protective clothing, including gloves and goggles
 One dummy plug for the open circulation piping (DN40)

Caution:

Be cautious when handling phosphorous acid. Wear protective gloves and goggles. Any phosphorous acid getting in contact with your skin should immediately be rinsed off using running water. When getting in contact with your eyes, the acid should immediately be rinsed also using running water; afterwards you should immediately consult a doctor.

Caution:

Prior to any maintenance work the moisture measurement should be deactivated, i.e. the analyser is switched off; refer to subchapter "Deactivating the analyser(s)".

Figure 3: Procedure for Cleaning Moisture Sensor

1



Disconnect plug connector.

2



Loosen clamp.

3



Insert dummy plug.

4



Tighten flange clamp.

5



Unscrew protective cover.

6



Moisten sensor with distilled water.

7



Carefully clean and dry winding.

8



Moisten winding with phosphorous acid.

9



Remount protective cover.

10

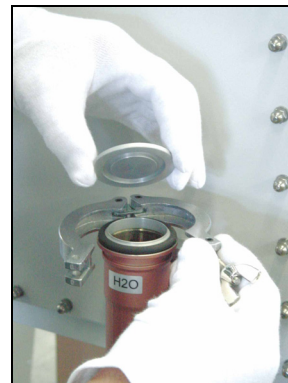

Remove clamp and dummy plug.

11



Insert measuring probe and re-clamp.

12



Tighten clamp.

13



Insert plug connector.

Contents

16.1. General Information 2

16.2. Operation of the Box Cooling Unit 2

16.3. Setting the Box Cooling Parameters 3

16.1. General Information

The purpose of the cooling unit is to cool the Glove Box atmosphere after being exposed to excess heat. This heat source may be from an oven/furnace, welding or from plasma burning within the system etc.

The cooling unit directs a cooling airflow to a specific area, therefore allowing the maximum cooling effect on items that are placed in the current. The normal Glove Box circulation will cause an overall cooling effect within the system.

Caution:
When the cooling unit is not in operation, there is a reduced airflow with the unit. Therefore, during manual purging, extra care is required for the area around the cooling unit to ensure that the area is completely purged.

The range of the Box Cooling Temperature is +10°C to +40°C

16.2. Operation of the Box Cooling Unit

The cooling unit is controlled by the Touch Panel.

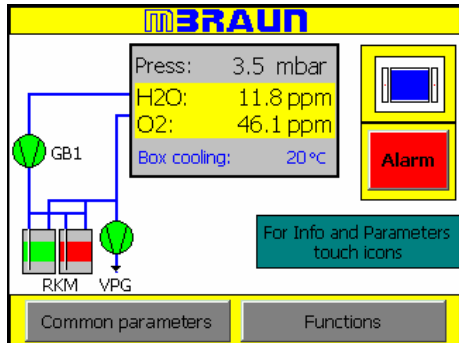

To activate the Box Cooling function select the Functions Button on the Start Screen.

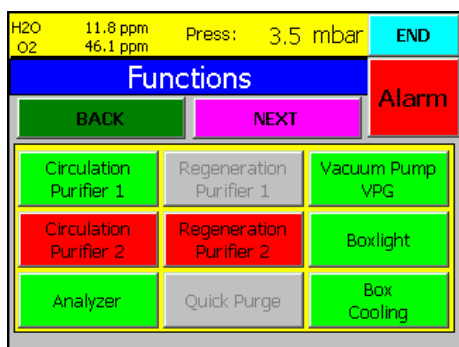

Select the “Box Cooling” button.

The button will turn to green when the Box Cooling is active.

To deactivate the “Box Cooling” select the button again – the button will return to the colour red.

16.3. Setting the Box Cooling Parameters

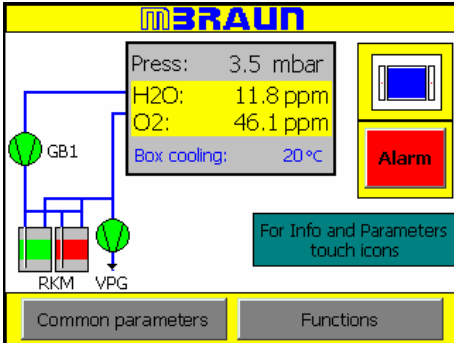

Select the “Common Parameters” button on the start screen.

Note:
If the Glove-Box is equipped with a Box Cooling unit the current temperature will be displayed on the “Start Screen”.

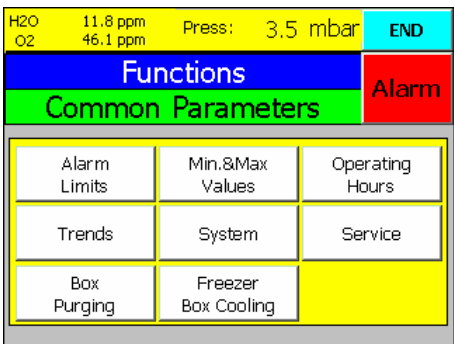

Select the “Freezer/Box Cooling” Button from the common Parameters screen to access the Parameter Screen for the Box Cooling Unit.

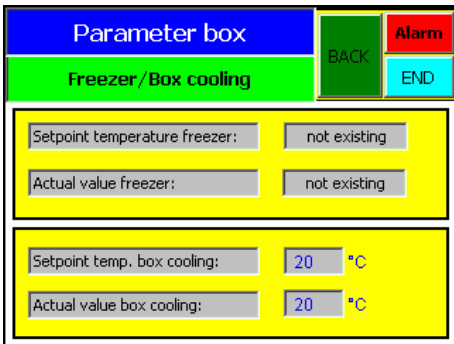

The Temperature may be set by selecting the input field “Setpoint temp. box cooling:”
Enter the desired temperature and press the enter button.

The range for the box cooling is from +10°C to +40°C.

If the unit is active, the cooling unit will start cooling when the setpoint temperature is over-stepped.

Blank Page

Contents

17.1.	General Information	2
17.2.	Purging the Freezer	2
17.3.	Operation of the Freezer.....	3
17.4.	Setting the Freezer Parameters	4
	<i>Table of Figures</i>	
	<i>Figure 1: Freezer - Door Closed.....</i>	<i>2</i>
	<i>Figure 2: Freezer – Door Open</i>	<i>2</i>

17.1. General Information



Inner dimensions

Height..... 423.0 mm
 Width..... 266.0 mm
 Depth 162.5 mm

Inner volume ±18.3 litres

Cooling Function

Cooling Range +10°C to -35°C
 (-30°C if ambient temp > 30°C)

Ambient Temp. Range..... 0°C to +32°C

Figure 1: Freezer - Door Closed

17.2. Purging the Freezer

Caution:

It is important that the interior of the freezer is fully purged of ambient atmosphere before the Glove Box is used. Failure to purge this area could cause the box atmosphere to become polluted upon opening of the freezer door, thus causing damage to the box equipment, and/or material within the Glove Box.



Figure 2: Freezer – Door Open

Before the Glove Box is used the System must be purged (see Chapter – Purging the System). During the Glove Box purging process it is important that all areas are fully purged of ambient atmosphere. With the freezer in the Glove Box it is important that not only the area around the freezer unit is purged but also the area within the Freezer.

17.3. Operation of the Freezer

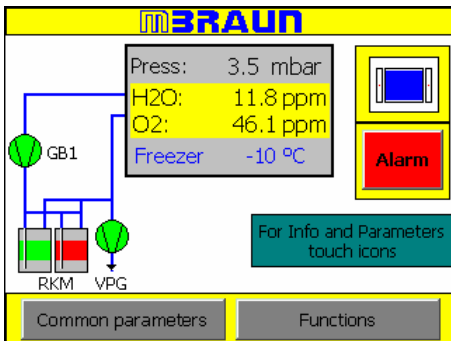

To Activate the Freezer function select the Functions Button on the Start Screen.

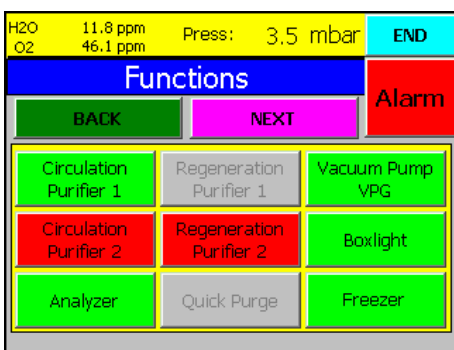

Select the "Freezer" button.

The button will turn to green when the Freezer is active.

To deactivate the "Freezer" select the button again – the button will return to the colour red.

The inner temperature of the freezer is controlled by the Touch Panel. (See Setting of Freezer Parameters below)

The door for the freezer is opened, closed and secured by a lever attached to the door. For additional security the door may be locked with a key.

Within the Freezer compartment there are shelf supports to give a range of settings for additional shelving.

17.4. Setting the Freezer Parameters

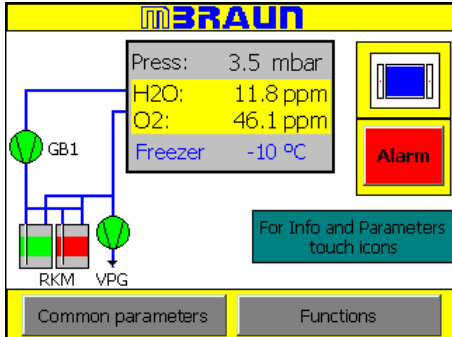

Select the “Common Parameters” button on the start screen.

Note:
If the Glove-Box is fitted with a freezer unit the current temperature will be displayed on the “Start Screen”.

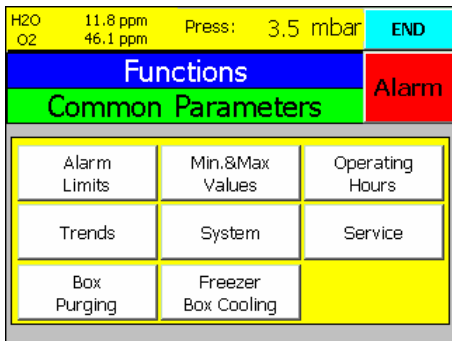

Select the “Freezer/Box Cooling” Button from the common Parameters screen to access the Parameter Screen for the Freezer Unit.

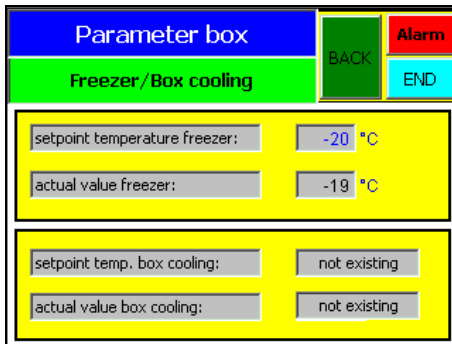

The Temperature may be set by selecting the input field “Setpoint Temperature Freezer:” Enter the desired temperature and press the enter button.

Range for freezer temperature is from -40°C to +20°C.

Note:
The “actual value freezer” field returns the current temperature within the freezer – the value is generated by the system.

Contents

18.1.	General Information	2
18.2.	Technical Data	2
18.3.	Exchanging Dust Filters	3
18.3.1.	Method for Exchanging the Filter:	3
	 <i>Table of Figures</i>	
	<i>Figure 1: Removing Filter</i>	<i>3</i>
	<i>Figure 2: Replacing Filter</i>	<i>3</i>

18.1. General Information

MBRAUN glove boxes are equipped with dust filters at the gas outlet, as well as, at the gas inlet piping. The former protects the gas purification system against dust particles the maybe generated by the user inside the glove box. The latter filter ensure optimal particle free incoming gas.

18.2. Technical Data

The filter that is commonly used within the M.Braun Glove Box system has the following characteristics:-

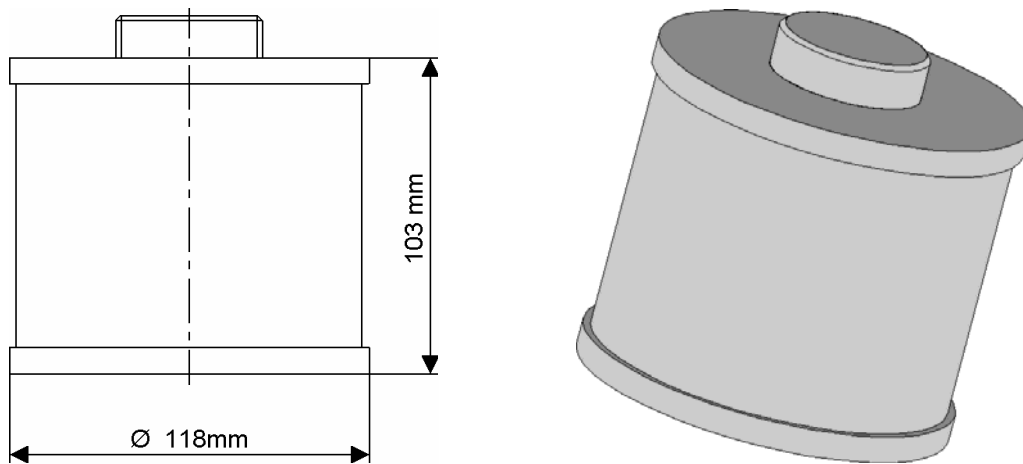

The standard filter is of a HEPA format (class H14)- i.e. filtering 99.995% of particles – typically down to 0.2 microns.

Note:

M.Braun can also supply finer filters (e.g. Class U15 – Filtering 99.9995% of particles) upon request.

18.3. Exchanging Dust Filters

Depending on the usage of the glove box system the filters need to be exchanged at least once a year.

18.3.1. Method for Exchanging the Filter:

Figure 1: Removing Filter

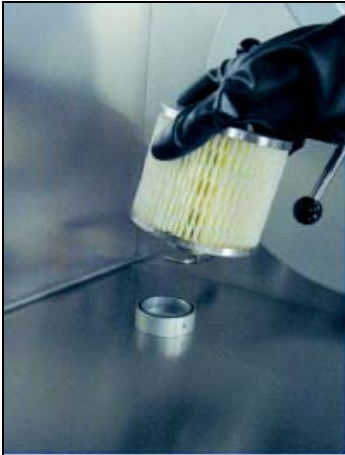

Unscrew used dust filter.

Figure 2: Replacing Filter



Screw new dust filter in place.

Note:

Depending upon the substances used inside the glove box, the replaced filter may need to be treated with care outside of the glove box atmosphere. Please refer to all local Environmental, Safety and Health guidelines that may apply for the type of substances used within the glove box.

Blank Page

Contents

19.1. General Information 2

19.2. Technical Data 2

19.3. Replacing Gloves 3

19.4. Glove Port Covers 4

19.5. Standard Spare Parts and Accessories for M.Braun Gloves 5

19.1. General Information

M.Braun exclusively uses gloves made of butyl. A feature of this flexible material is the good comfortable grip even at low temperatures (Temperature range from -40 °C to +90 °C). The following graphic chart shows, that butyl compared to hypalon and neoprene evidently has the most favourable values regarding the permeability for different gases and for water vapour.

Note:
For working with higher temperatures M.Braun also offers gloves made of butyl with a hypalon layer.

Gas Permeability Constant Comparison Chart

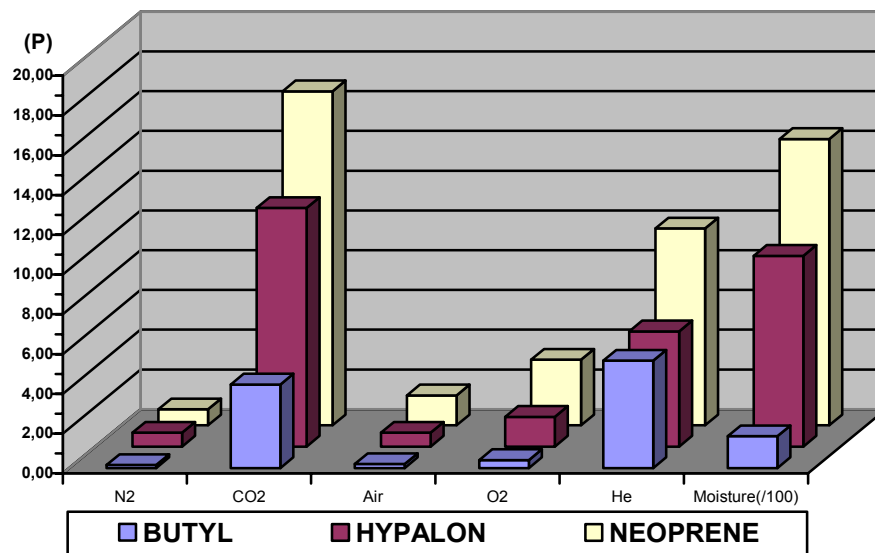

Note:
Permeability Constant (P) = gas flow through a material of 1cm thickness at a standard pressure and temperature. It is measured at a rate of 10⁻⁹ cm³ gas/s.

19.2. Technical Data

Product:MB Gloves.

Type:.....Special gloves made of brom-butyl for Glove Box Systems.

Design:.....Various diameters, sizes and shapes.

19.3. Replacing Gloves

Recommendation:

M.Braun recommends that the gloves are replaced at regular intervals. The gloves must be changed upon signs of wear and tear that may or have caused a leak.

Caution:

Before changing gloves ensure that the glove box atmosphere is safe to breathe. If necessary purge and fill the glove box with ambient air before attempting to change gloves.

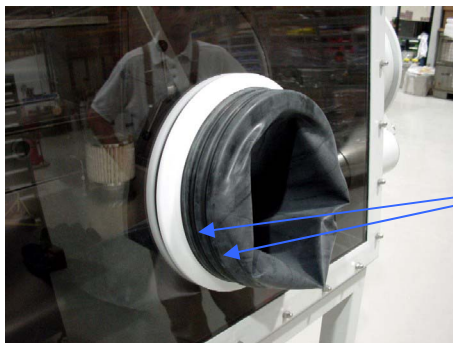

The Gloves are secured by two O-rings.

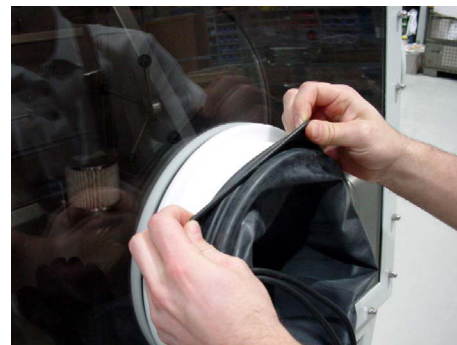

To remove the gloves remove the O-rings and removes the glove as shown

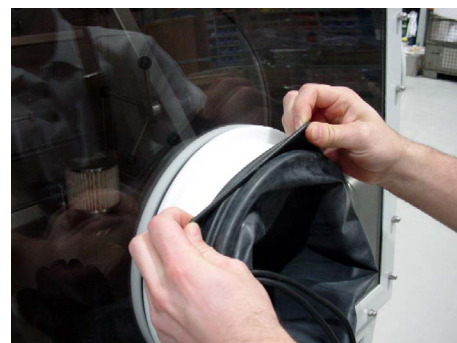

To replace the glove - place the glove over the port so that the rim of the glove locates in the port's innermost groove (the outer 2 grooves are for locating the O-rings that secure the glove).

Caution:

Ensure that the correct type of glove is chosen e.g. left or right hand, or ambidextrous and of the correct size



Check that the glove is orientated correctly and replace with new O-rings.

Note:

After the changing of gloves the glove box atmosphere will require purging to remove any undesired oxygen and/or moisture. (see chapter on Purging the System)

19.4. Glove Port Covers

MBRAUN glove port covers are available as an option. The glove port covers are for standard round glove ports and are available for either interior or exterior fitting.

The inner-glove port covers allow for the changing of gloves whilst preventing the influx of the outer-atmosphere into the glove box.

The outer-glove port prevents un-required gloves from being an obstruction when operating the box above atmospheric pressure.

Glove port covers can be ordered from M.Braun Service Department

Caution:

Do not concurrently seal all glove ports.

19.5. Standard Spare Parts and Accessories for M.Braun Gloves

M.Braun Order No.	Description	Connection Diameter	Glove Thickness	Size
3000047	Brom-butyl anatomical Glove	220 mm	0.4 mm	Large
3000048	Brom-butyl anatomical Glove	220 mm	0.8 mm	Large
3240567	Brom-butyl ambidextrous Glove	220 mm	0.4 mm	Large
2340568	Brom-butyl ambidextrous Glove	220 mm	0.8 mm	Large
3000018	Brom-butyl anatomical Glove	220 mm	0.4 mm	Medium
3005010	Hypalon anatomical Glove	220 mm	0.4 mm	Large
3005009	Hypalon ambidextrous Glove	220 mm	0.4 mm	Large
3000050	Brom-butyl anatomical Glove	160 mm	0.4 mm	Large
3000051	Brom-butyl ambidextrous Glove	160 mm	0.4 mm	Large
3005008	Brom-butyl ambidextrous Glove	Oval	0.4 mm	Large
2600239	O-Ring for Gloves	220 mm		
2600240	O-Ring for Gloves	160 mm		
9002371	Internal Glove Port Cover	220 mm		
7019882	External Glove Port Cover	220 mm		
7024831	Internal Glove Port Cover	160 mm		
7024791	External Glove Port Cover	160 mm		
9004663	Glove Port Feed-Through	220 mm		
2400138	O-Ring (250*4) for Inner Glove Port Feed-Through	220 mm		
2400117	O-Ring (244*7) for Outer Glove Port Feed-Through	220 mm		
9004667	Glove Port Feed-Through	160 mm		

Other gloves, as well as O-Rings, are available by request from M.Braun Service Department.

Blank Page

Contents

20.1. Components of Third-Party Manufacturers..... 2

20.2. Regular Maintenance and Service..... 3

20.3. Quarterly and Annual Maintenance and Service 4

20.1. Components of Third-Party Manufacturers

MBRAUN Glove Box systems are partly equipped with third-party manufacturers' components such as:

- Vacuum pump(s)
- Compressor(s) for the system's compressor cooling
- Compressor(s) for refrigerator systems
- PLC control components (Siemens)
- **TOUCH Screen** Operation Panel (Siemens)

The original third-party manufacturers' documents, in which the maintenance and service of the components are described, are included in the systems delivery.

Caution:

The third-party manufacturers' maintenance and service instructions should be followed.

20.2. Regular Maintenance and Service

Main glove box and window

Clean the exterior using conventional detergents (do not use caustic detergents); for this purpose use a soft, lint free cloth; or a vacuum cleaner if available, using a brush attachment.

Note:

If the Box is equipped with an **MBRAUN Clean-Jet** unit then the interior of the box and window may also be vacuumed with a brush attachment.

Gloves

Check the gloves for damage; in addition, use linen gloves to avoid humidity in the box gloves.

Caution:

Do not use powder within the box or within a clean room environment. Replace gloves when damaged - by no means attempt to repair gloves.

Antechambers

Check antechamber seals for damage. If the antechamber doors are difficult to open or to close, grease or lubricate threads lightly.

Caution:

Some areas of the system must be left without grease or lubrication. In this case, grease or lubricants should not be used.

Connections

Check connections for firm seat and are leak free.

Components

Observe the maintenance instructions of the optional equipment components, such as analyser and refrigerator.

Observe the third-party manufacturers' maintenance instructions.

20.3. Quarterly and Annual Maintenance and Service

Type of System	Quarterly	Annually
Glove Box	<ul style="list-style-type: none"> • Check the Omega sealing for the windows • Check the gloves and glove ports • Check the magnetic valves • Complete leakage test • Function test 	<ul style="list-style-type: none"> • Check and if necessary replace the sealing for the windows • Check the Omega sealing of the windows • Check the gloves and glove ports • Check the illuminating equipment • Check and if necessary replace the dust filters • Check and if necessary replace the magnetic valves • Complete leakage test • Function test
Gas Purification System	<ul style="list-style-type: none"> • Check the magnetic valves • Check the blower • Check the vacuum pump • Complete leakage test • Function Test 	<ul style="list-style-type: none"> • Check the vacuum pump • Check and if necessary replace the circulation blower • Check and if necessary replace the filter medium • Dismantle pipe-work and clean it. Replace all Viton seals • Check and if necessary replace the valve seals • Check the cooling system • Check the cooling fluid • Complete leakage test • Function test
Analysers	<ul style="list-style-type: none"> • Check the sensors • Check the flow rate meter • Complete leakage test 	<ul style="list-style-type: none"> • Check and if necessary replace sensors • Check the vacuum pump • Leak test piping • Complete leakage test • Check calibration

CONTENTS

21.1. General Information2

21.2. Alarm and Warning Messages2

21.3. Definition of Error Messages3

21.1. General Information



On all screen of the TP170B Operation Panel (*TOUCH* Screen) appears the Alarm icon. As soon as a fault or an error the “Alarm” button will flash

21.2. Alarm and Warning Messages

To view the error messages, push the “Alarm” button. This will open the Warnings Screen. The “Alarm” Button appears in each screen.

Figure 1: Warning Screen

No.	Time	Text
106	12:48:16	purifier 1: H2O alarm
108	12:17:13	purifier 1: O2 alarm

The messages that appear in the screen are in order of occurrence. The most recent message is the uppermost.



To acknowledge that a message has been read, select the message by touching the screen. The message will become highlighted on the screen. Select the Acknowledge button.

Messages that are no longer valid (e.g. the moisture sensor reading is again within the alarm limit range) will be removed from the screen upon being acknowledged.

Selecting the “Back” button will return to the previous screen.

21.3. Definition of Error Messages

Warning Number	Warning Description	Possible Explanations	Solutions
1	vacuum pump VPG 1 switched off	Operator has not switched vacuum pump on	Operator have to switch on vacuum pump
2	motor protective switch vacuum pump VPG 1 activated	Vacuum pump faulty Coarse-leak in the piping (vacuum pump overworked due to size of the leak)	Replace vacuum pump Eliminate Coarse-leak Vacuum pump check from MBraun - Service
3	blower GB1: motor protective switch activated or error frequency controller	Main blower faulty Main piping stopped up	Replace main blower Eliminate Constipation Blower check from MBraun - Service
4	purifier 1: filter 1 input main valve not open	Main valve faulty Control pressure too low	Replace main valve Set control pressure to 6 bar
5	purifier 1: filter 1 output main valve not open	Main valve faulty Control pressure too low	Replace main valve Set control pressure to 6 bar
6	purifier 1: filter 2 input main valve not open	Main valve faulty Control pressure too low	Replace main valve Set control pressure to 6 bar
7	purifier 1: filter 2 output main valve not open	Main valve faulty Control pressure too low	Replace main valve Set control pressure to 6 bar
8	purifier 1: pressure working gas too low	Working gas pressure too low Pressure-supervision defective or put in incorrectly	Set working gas pressure to 6bar Pressure supervision reset Adjust pressure-supervision switch
9	purifier 1: pressure purging gas too low	Pressure purging gas too low Pressure-supervision defective or put in incorrectly	Set purging gas pressure to 6bar Pressure supervision reset Adjust pressure-supervision switch
10	purifier 1: box purging outlet not open	Purging valve faulty Control pressure too low	Purging valve Replaces Set control pressure to 6 bar
11	purifier 1: box purging in operation	Operator-hint	No action required
12	purifier 1: fuse filter heater activated	Filter heater faulty	Heater check from MBraun - Service
13	purifier 1: temperature alarm filter	Option: Filter Temperature Alarm Temperature Filter too high → Solid state relay is faulty Thermocouple faulty	Reset Sensor – Before cancelling Alarm Heater Faulty – Heater check from MBraun Service Sensor Faulty – Cable Faulty

Warning Number	Warning Description	Possible Explanations	Solutions
33	Solvent trap: Main valve filter 1 inlet/outlet not open	Main valve Solvent trap faulty Control pressure too low	Replace Main valve Set control pressure to 6 bar
34	Solvent trap: Main valve filter 2 inlet/outlet not open	Main valve Solvent trap faulty Control pressure too low	Replace Main valve Set control pressure to 6 bar
35	Solvent trap: Main valve filter 1 inlet/outlet not closed	Main valve Solvent trap faulty Control pressure not correct	Replace Main valve Set control pressure to 6 bar
36	Solvent trap: Main valve filter 2 inlet/outlet not closed	Main valve Solvent trap faulty Control pressure not correct	Replace Main valve Set control pressure to 6 bar
37	Solvent trap: Roughing valve not open	Roughing valve Solvent trap faulty Control pressure too low	Replace Roughing valve Set control pressure to 6 bar
38	Solvent trap: motor protective switch vacuum pump VPGL	Vacuum pump faulty Coarse-leak in the piping (vacuum pump overworked due to size of the leak)	Replace Vacuum pump Eliminate Coarse-leak Vacuum pump check from MBraun - Service
45	motor protective switch vacuum pump VP1 activated	Vacuum pump faulty Coarse-leak in the piping (vacuum pump overworked due to size of the leak)	Replace Vacuum pump Eliminate Coarse-leak Vacuum pump check from MBraun - Service
46	motor protective switch vacuum pump VP2 activated	Vacuum pump faulty Coarse-leak in the piping (vacuum pump overworked due to size of the leak)	Replace Vacuum pump Eliminate Coarse-leak Vacuum pump check from MBraun - Service
47	motor protective switch vacuum pump VP3 activated	Vacuum pump faulty Coarse-leak in the piping (vacuum pump overworked due to size of the leak)	Replace Vacuum pump Eliminate Coarse-leak Vacuum pump check from MBraun - Service
49	compressor: motor protective switch activated	Compressor purifier faulty	Replace Compressor Compressor check from MBraun - Service
51	freezer: motor protective switch activated	Compressor freezer faulty	Replace Compressor Compressor check from MBraun - Service
52	compressor box cooling: motor protective switch activated	Compressor box cooling faulty	Replace Compressor Compressor check from MBraun - Service
55	oxygen-level too high: automatic box purging is active	Operator-hint :Oxygen-measurement over O2-limit level → Box purging starts automatically	No action required
56	box pressure to high: purging output valve is open	Gas hose broken in the box	Disconnect leaking gas supply

Warning Number	Warning Description	Possible Explanations	Solutions
57	box pressure to low: automatic purging is active	Vacuum valve antechamber has not closed Refill valve antechamber has not closed Vacuum valve purifier has not closed	replace faulty valve
59	spin coater: exhaust valve not open	Exhaust valve spin coater faulty Control pressure too low	Replace Exhaust valve Set control pressure to 6 bar
65	vacuum pump off - box pressure too low	Vacuum valve antechamber has not closed Refill valve antechamber has not closed Vacuum valve purifier has not closed	Replace faulty valve and switch on vacuum pump
96	Clean the H2O-sensor - Refer to instruction manual	Maintenance time H2O-Sensor overstepped	Clean H2O-Sensor Reset maintenance time H2O-Sensor
97	purifier 1: filter 1 input main valve not closed	Main valve purifier 1 faulty Control pressure too low	Replace Main valve Set control pressure to 6 bar
98	purifier 1: filter 1 output main valve not closed	Main valve purifier 1 faulty Control pressure too low	Replace Main valve Set control pressure to 6 bar
99	purifier 1: regeneration filter 1 in operation	Operator hint	No action required
100	purifier 1: regeneration filter 1 service mode	Operating hint	No action required
101	Purifier 1: proof flow regeneration gas - ok?	Regeneration gas confirmation by the customer	Check gas flow regeneration gas and confirm condition
102	purifier 1: filter 2 input main valve not closed	Main valve purifier 2 faulty Control pressure too low	Replace Main valve Set control pressure to 6 bar
103	purifier 1: filter 2 output main valve not closed	Main valve purifier 2 faulty Control pressure too low	Main valve Replaces Set control pressure to 6 bar
104	purifier 1: regeneration filter 2 in operation	Operator hint	No action required
105	purifier 1: regeneration filter 2 service mode	Operator hint	No action required
106	purifier 1: H2O alarm	H2O-Measurement exceeds alarm-threshold: Antechamber leaky , piping leaky Introduced item contains much moisture No cleaning effect of the active filter	Eliminate leakage Complete more pump-refill-cycles for the introduced item Regenerate filter, use regenerated filter

Warning Number	Warning Description	Possible Explanations	Solutions
107	purifier 1: H2O sensor defective	H2O-sensor faulty H2O-sensor unplugged	Replace H2O-sensor Plug-in H2O-sensor
108	purifier 1: O2 alarm	O2-Measurement exceeds alarm-threshold: Antechamber leaky , piping leaky Introduced item contains much oxygen No cleaning effect of the active filter	Eliminate leakage Complete more pump-refill-cycles for the introduced item Regenerate filter, use regenerated filter
109	purifier 1: O2 sensor defective	O2-sensor faulty O2-sensor unplugged	Replace O2-sensor O2-sensor plug in
110	purifier 1: blower pressure sensor defective	Blower-pressure-sensor faulty Blower-pressure -sensor unplugged	Replace Blower-pressure -sensor Plug-in Blower-pressure -sensor
111	purifier 1: blower pressure too low	Main-blower does not run: Main-blower unplugged Main-blower faulty	Plug in main-blower Replace Main-blower
112	purifier 1: blower pressure too high	HEPA-filter contaminated	Replace HEPA-filter
113	purifier 1: pressure sensor regeneration gas defective	Option: pressure sensor regeneration gas pressure sensor regeneration gas faulty	Replace pressure sensor regeneration gas
114	purifier 1: regeneration gas pressure too low	Option: pressure sensor regeneration gas Gas supply empty Pressure attitude too low	Change gas bottle Adjust gas -pressure (0,3 – 0,5 bar) Adjust gas pressure (0,3 – 0,5 bar)
115	purifier 1: regeneration gas pressure too high	Option: pressure sensor regeneration gas Pressure attitude too high	Adjust gas pressure (0,3 – 0,5 bar)
140	Solvent trap: Filter 1 inlet main valve not closed	Main valve solvent trap filter 1 faulty Control pressure too low	Replace Main valve solvent trap filter 1 Set control pressure to 6 bar
141	Solvent trap: Filter 1 outlet main valve not closed	Main valve solvent trap filter 1 faulty Control pressure too low	Replace Main valve solvent trap filter 1 Set control pressure to 6 bar
142	Solvent trap: Prove purge gas flow for regeneration	Purge-gas confirmation by the customer	Check gas flow purge-gas and confirm condition
143	Solvent trap: Filter 2 inlet main valve not closed	Main valve solvent trap filter 2 faulty Control pressure too low	Replace Main valve solvent trap filter 2 Set control pressure to 6 bar
144	Solvent trap: Filter 2 outlet main valve not closed	Main valve solvent trap filter 2 faulty Control pressure too low	Replace Main valve solvent trap filter 2 Set control pressure to 6 bar

Warning Number	Warning Description	Possible Explanations	Solutions
145	Solvent trap: alarm setpoint analyzer exceeded --> Regenerate solvent trap	Analyzer-measurement exceeds alarm-threshold:	Regenerate filter, use regenerated filter
160	antechamber 1: atmosphere sensor defective	Atmosphere-sensor faulty Atmosphere -sensor unplugged	Replace Atmosphere-sensor Atmosphere-sensor plug in
161	antechamber 1: vacuum sensor defective	Vacuum-sensor faulty Vacuum -sensor unplugged	Replace Vacuum-sensor Vacuum-sensor plug in
162	antechamber 1: inner door not closed	Door switch not activated: Door switch faulty Door not completely closed	Replace Door switch Close door
163	antechamber 1: outer door not closed	Door switch not activated: Door switch faulty Door not completely closed	Replace Door switch Close door
164	antechamber 1: pumping time exceeded	Antechamber leaky Vacuum piping leaky Rank gases too strongly	Eliminate leak Increase max. evacuation-time
167	antechamber 1: antechamber leaking	Leakiest was not ok: Fine leak antechamber Fine leak piping	Eliminate leak
168	antechamber 1: no cooling water or water flow -- reset yellow button ACK --	Option: Oven-antechamber Water supply not sufficient	Check that the water-supply is enough
169	antechamber 1: no pressure emergency cooling	Option: Oven-antechamber Water supply not sufficient	Check that the water-supply is enough
170	antechamber 1: temperature alarm - Eurotherm	Option: Oven-antechamber Temperature oven too high → Solid state relay is faulty Thermocouple faulty Temperature alarm level too near at the setpoint	Replace Solid state relay Replace Thermocouple Adjust temperature alarm level
171	antechamber 1: error temperature sensor	Option: Oven-antechamber Thermocouple faulty	Replace Thermocouple
172	antechamber 1: pressure too high for heating	Option: Oven-antechamber Heater condition handmade: vacuum must be better than 1 mbar	Evacuate antechamber up to the necessary vacuum level
175	antechamber 2: atmosphere sensor defective	Atmosphere-sensor faulty Atmosphere -sensor unplugged	Replace Atmosphere-sensor Atmosphere-sensor plug in
176	antechamber 2: vacuum sensor defective	Vacuum-sensor faulty Vacuum -sensor unplugged	Replace Vacuum-sensor Vacuum-sensor plug in

Warning Number	Warning Description	Possible Explanations	Solutions
177	antechamber 2: inner door not closed	Door switch not activated: Door switch faulty Door not completely closed	Replace Door switch Close door
178	antechamber 2: outer door not closed	Door switch not activated: Door switch faulty Door not completely closed	Replace Door switch Close door
179	antechamber 2: pumping time exceeded	Antechamber leaky Vacuum piping leaky Rank gases too strongly	Eliminate leak Increase max. evacuation-time
182	antechamber 2: antechamber leaking	Leakiest was not ok: Fine leak antechamber Fine leak piping	Eliminate leak
183	antechamber 2: no cooling water or water flow -- reset yellow button ACK --	Option: Oven-antechamber Water supply not sufficient	Check that the water-supply is sufficient
184	antechamber 2: no pressure emergency cooling	Option: Oven-antechamber Water supply not sufficient	Check that the water-supply is sufficient
185	antechamber 2: temperature alarm – Eurotherm	Option: Oven-antechamber Temperature oven too high → Solid state relay is faulty Thermocouple faulty Temperature alarm level too near at the setpoint	Replace Solid state relay Thermocouple Replaces Adjust temperature alarm level
186	antechamber 2: error temperature sensor	Option: Oven-antechamber Thermocouple faulty	Replace Thermocouple
187	antechamber 2: pressure too high for heating	Option: Oven-antechamber Heater condition handmade: vacuum must be better than 1 mbar	Evacuate antechamber up to the necessary vacuum level
205	Buffer battery CPU is empty - exchange! Do not switch off power supply!	Buffer battery of the PLC is empty	Do not switch off PLC Change battery
207	box valves box 1 not opened	Box valve box 1 faulty Control pressure too low	Replace Box valve box 1 Set control pressure to 6 bar
208	box valves box 2 not opened	Box valve box 2 faulty Control pressure too low	Replace Box valve box 2 Set control pressure to 6 bar
210	system not ready	Both boxes has not opened: Box valves not ok Control pressure not ok Box valves have not switched on	Replace Box valves Adjust control pressure to 6 bar Switch on box valves
212	sensor box pressure defective	Box pressure-sensor faulty Box pressure -sensor unplugged	Replace Box pressure -sensor Box pressure -sensor plug in

Warning Number	Warning Description	Possible Explanations	Solutions
213	box pressure too low	Vacuum valve antechamber has not closed Refill valve antechamber has not closed Vacuum valve purifier has not closed	Remove faulty valve
214	box pressure too high	Gas hose broken in the box If the mistake appears with box purging: gas supply too high	Disconnect leaky gas supply Throttle gas supply
215	freezer: temperature too high	Freezer does not run: Freezer unplugged Freezer faulty	Plug in freezer Replace Freezer
216	box cooling: error temperature sensor	Temperature-sensor faulty Temperature -sensor unplugged	Replace Temperature -sensor Plug-in Temperature -sensor
217	freezer: error temperature sensor	Temperature-sensor faulty Temperature -sensor unplugged	Replace Temperature -sensor Plug-in Temperature -sensor
218	Solvent trap: alarm setpoint exceeded ---> Start regeneration LMF	Analyzer-measurement exceeds alarm-threshold:	Regenerate filter, use regenerated filter

Blank Page

Contents

22.1.	Touch Screen.....	2
22.2.	Gas Purification System MB-20G (with Optional Solvent Filter).....	3
22.3.	Gas Purification System MB-200G (with Optional Solvent Filter).....	4
22.4.	Workstation – UNI-lab.....	5
22.5.	Antechamber – UNI-lab.....	6
22.6.	Electrical Cabinet Components (1 Filter Systems).....	6
22.7.	Gas Purification System – Labmaster 130	9
22.8.	Antechamber – Labmaster 130.....	10
22.9.	Solvent Filter (LMF).....	11
22.10.	Analysers	12
22.11.	Vacuum Pump	13

22.1. Touch Screen

Item Number	MBRAUN Number	Description
1a	2600253	Touch Screen TP170 (mono)
1b	2600254	Touch Screen TP170 (colour)

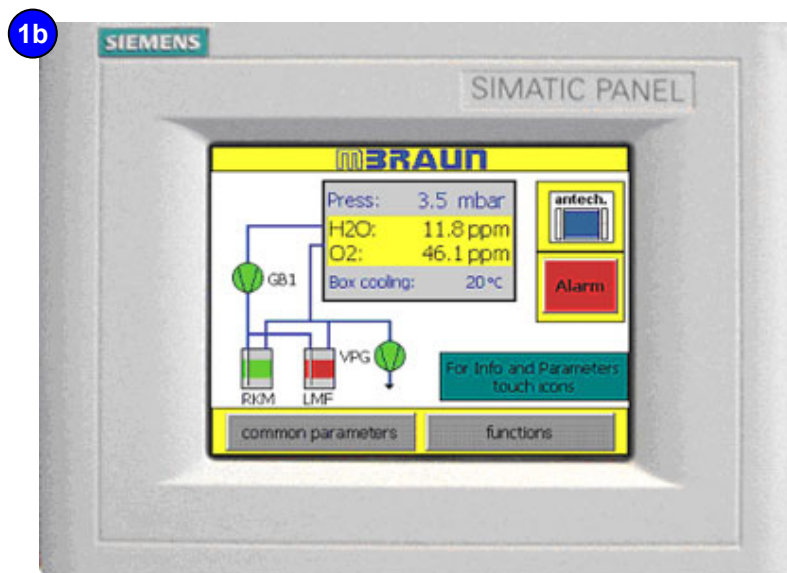
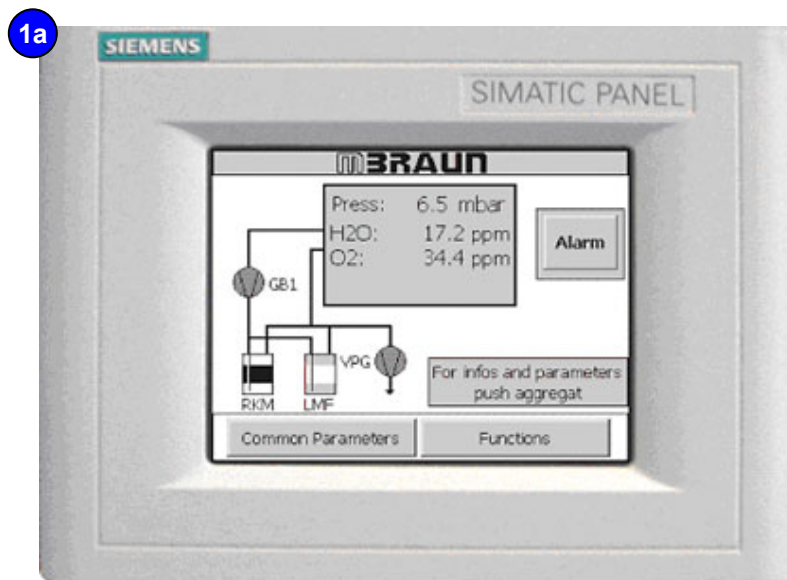

22.2. Gas Purification System MB-20G (with Optional Solvent Filter)

Item Number	MBRAUN Number	Description
1	3203000	Metal Tubing – DN40KF (350mm)
2	9004501	Butterfly Valve (KF40 V2A)
3	3240545	Metal Tubing – DN40KF (250mm)
4a	9007091	Solvent Filter (LMF)
4b	2182000	Activated Charcoal (5.5kg)
5	2200480	3-way Valve – 10mm MS
6	3000072	Manometer
7	4600978	Valve Set (spool, core, spring)
8a	9002531-K	Electro-pneumatic Valve (MB-EPV-40 – Lacquered)
8b	9002533-K	Electro-pneumatic Valve (MB-EPV-40 – Nickel Plated)
9	7016893	Heat Exchanger
10	9002043-KF	Reactor complete
10a	3240139	Cu-Catalyst (4.5kg)
10b	3240262	Molecular-Sieve (5.5kg)
11	3200072	Metal Tubing – DN40KF (500mm)
12	9002832	Blower (MB-BL-01)

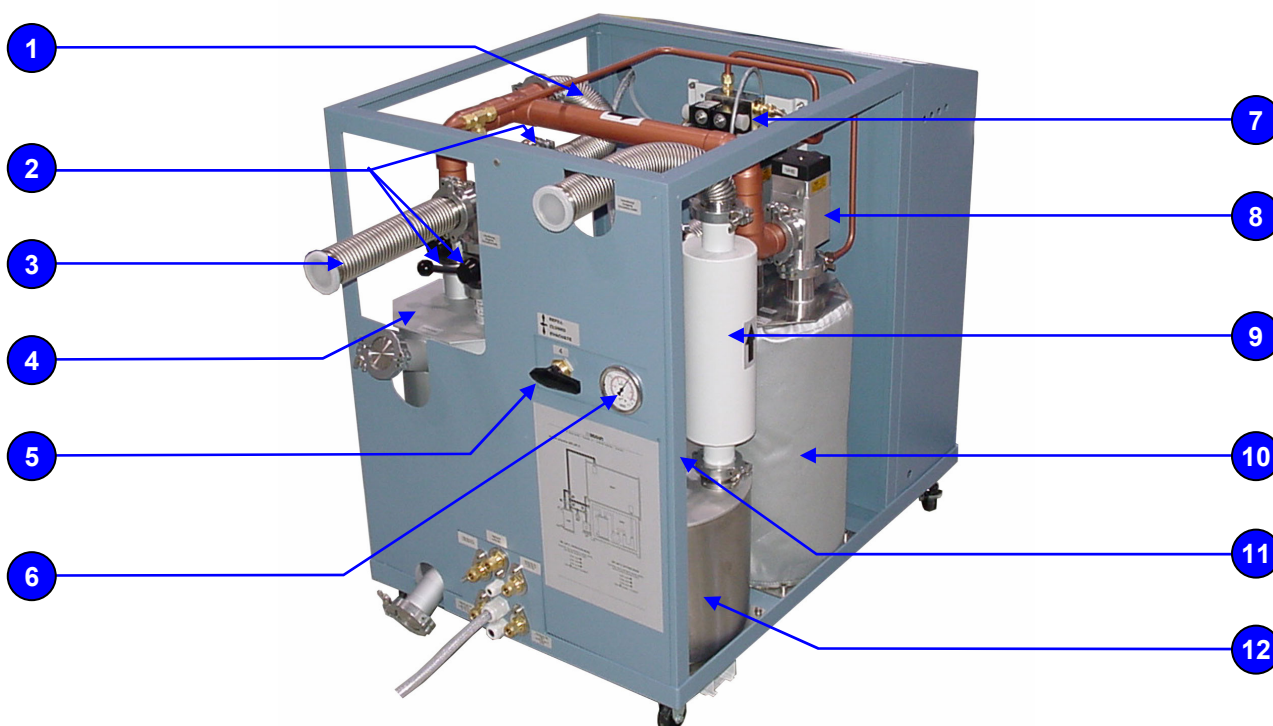

22.3. Gas Purification System MB-200G (with Optional Solvent Filter)

Item Number	MBRAUN Number	Description
1a	2600253	Touch Screen Operation Panel (TP170b/mono)
1b	2600254	Touch Screen Operation Panel (TP170b/colour)
2	3203000	Metal Tubing – DN40KF (350mm)
3	3240545	Metal Tubing – DN40KF (250mm)
4	3240521	Ball Valve
5	9004501	Butterfly Valve (KF40 V2A)
6a	9007091	Solvent Filter (LMF)
6b	2182000	Activated Charcoal (5.5kg)
7	2200480	3-way Valve – 10mm MS
8	3000072	Manometer
9	4600977	2/2 Way - Single Valve Block (spool, core, spring)
10	4600979	2/2 Way - 10 Valve Block (spool, core, spring)
11a	9002531-K	Electro-pneumatic Valve (MB-EPV-40 – Lacquered)
11b	9002533-K	Electro-pneumatic Valve (MB-EPV-40 – Nickel Plated)
12	4970007	Atmospheric Pressure Gauge
13	3200072	Metal Tubing – DN40KF (500mm)
14	7016893	Heat Exchanger
15	9002043-KF	Reactor complete
15a	3240139	Cu-Catalyst (4.5kg)
15b	3240262	Molecular-Sieve (5.5kg)
16	9002832	Blower (MB-BL-01)

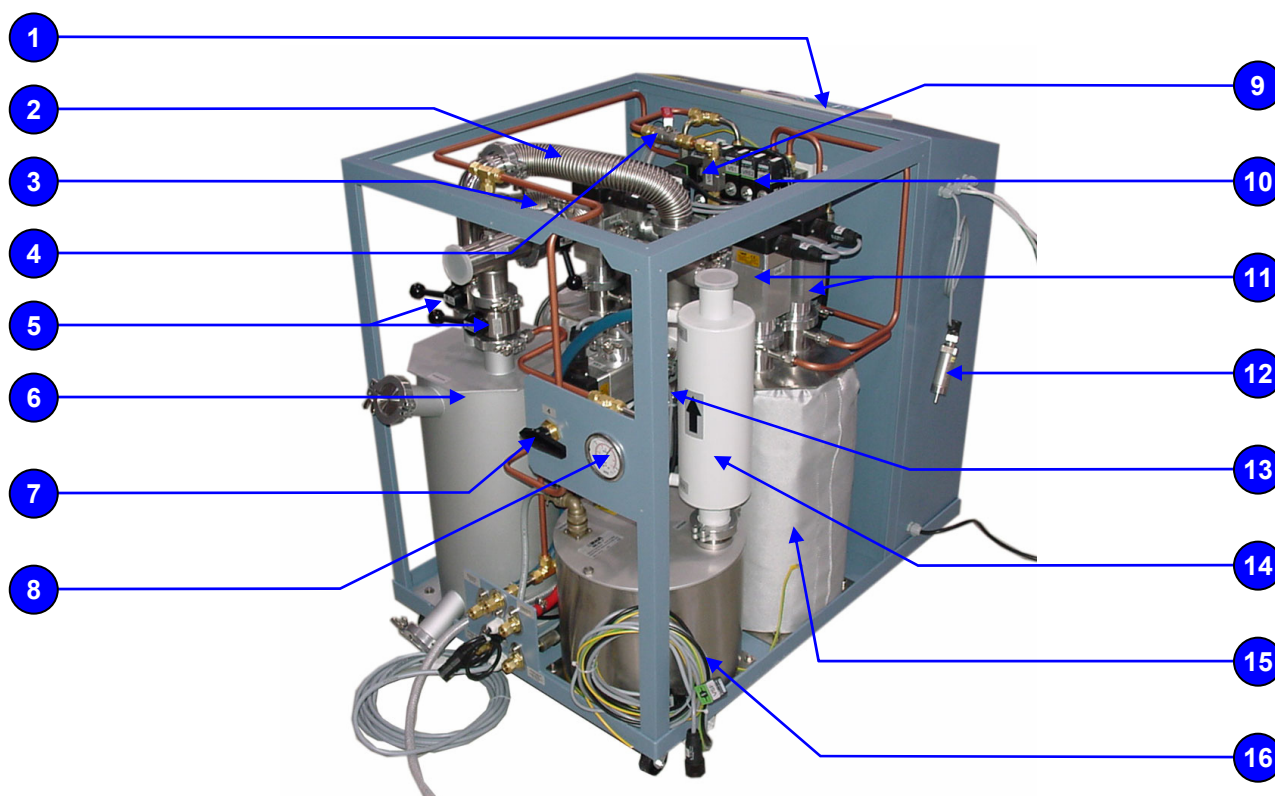

22.4. Workstation – UNI-lab

Item Number	MBRAUN Number	Description
1	1009012	Fluorescent Tube
2	---	Glove Port (see section 19.5 – Gloves)
3	---	O-Rings (see section 19.5 – Gloves)
4	---	Gloves (see section 19.5 – Gloves)
5	9004513	Dust Filter (MB-BF-L-03)
6	---	Antechamber (see section 21.4)
7	---	Touch Screen (see section 21.1)
8	3240052	Flow-meter
8a	2299000	Non-return Valve (fitted rear of flowmeter)
9	5001253	Main Switch
10	5007021	Foot Pedal (GF2)

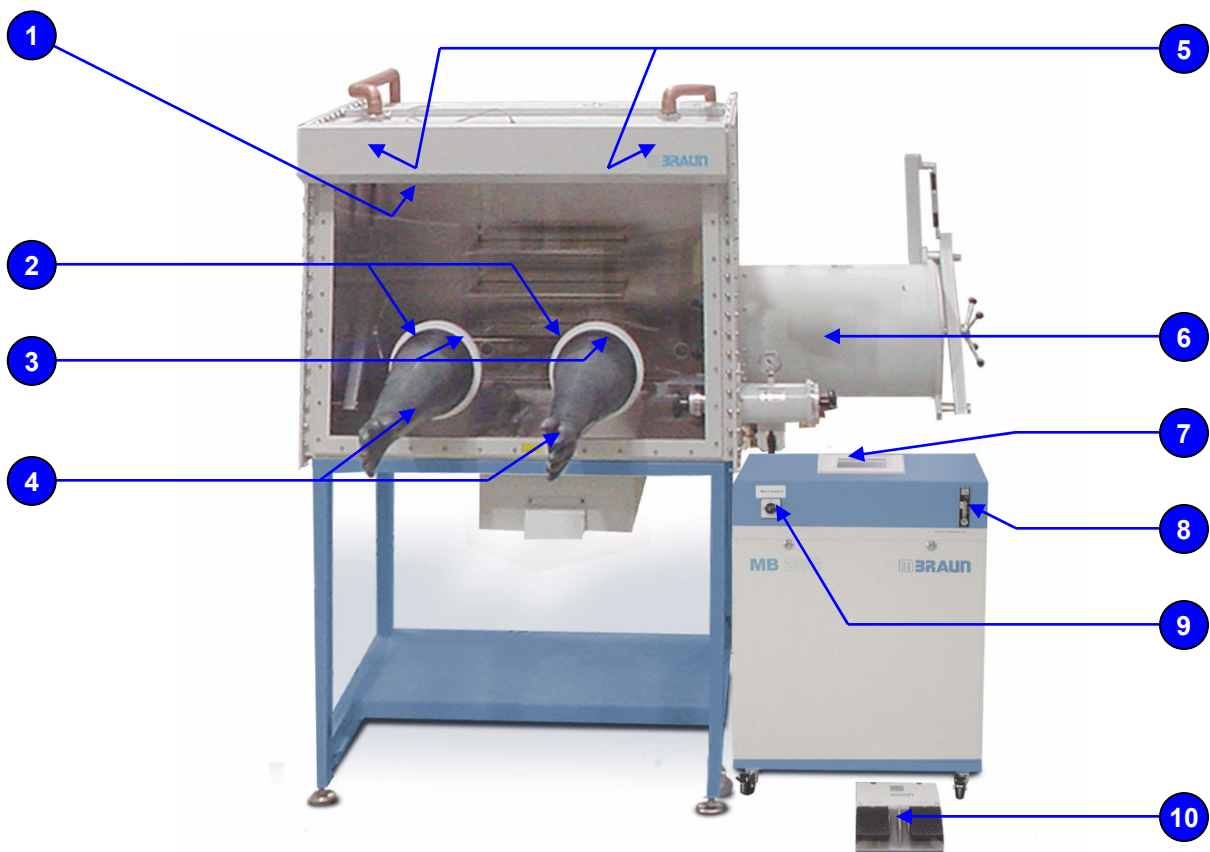

22.5. Antechamber – UNI-lab

Item Number	MBRAUN Number	Description
1	2405004	Manometer
2	2400171	O-Ring for Mini-Antechamber Cover
3	7003367	Mini-Antechamber Inner/Outer Cover
4	2200480	Butterfly valve 10mm MS
5	3240327	Pneumatic Spring
6	7003674	Cover
7a	9005225	Antechamber Cover complete (Right)
7b	9005226	Antechamber Cover complete (Left)
8	3000016	Capstan Handle
9	2400309	O-Ring for antechamber Inside and Outside
10a	7003798	Antechamber Bar (Right)
10b	7003799	Antechamber Bar (Left)
11	3240083	Ball Valve 3/8"
12	9004501	Hand Valve DN40 VA

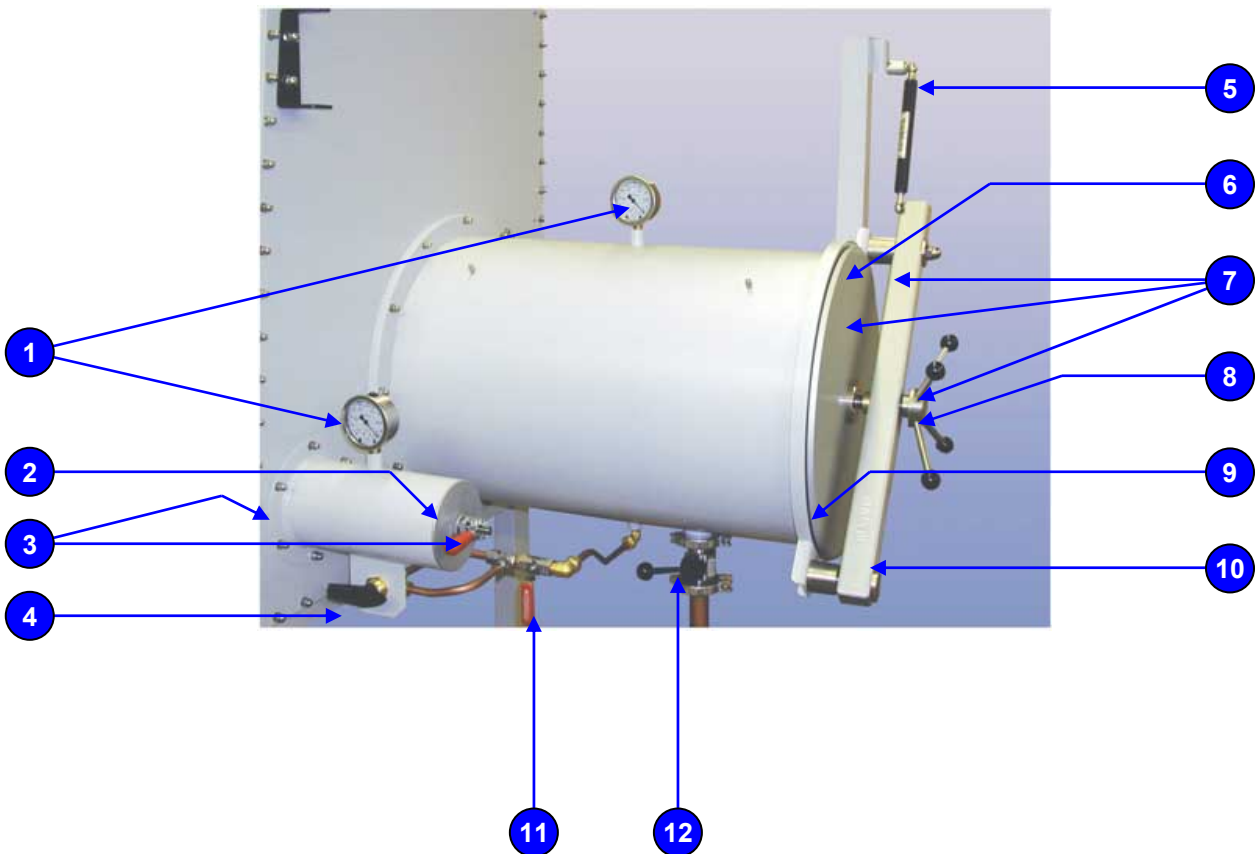

22.6. Electrical Cabinet Components (1 Filter Systems)

Item Number	MBRAUN Number	Description
-------------	---------------	-------------

1	5001253	Main Switch
2	5008278	Power Supply (5A)
3	2600241	Micro Memory Card (64kb)
4	2600036	PLC (313C)
5	5008168	Analogue Input Card (2xAI)
6	2600182	Frequency Controller (MM410)
7	2600180	Frequency Controller Panel (MM410 BOP)
8	5008078	Protective Switch C6A
9	5001040	Fuse 5x20 (24V) T 4A
10	5006004	Protective Motor Switch (2.8 – 4A
11	5001383	Relay

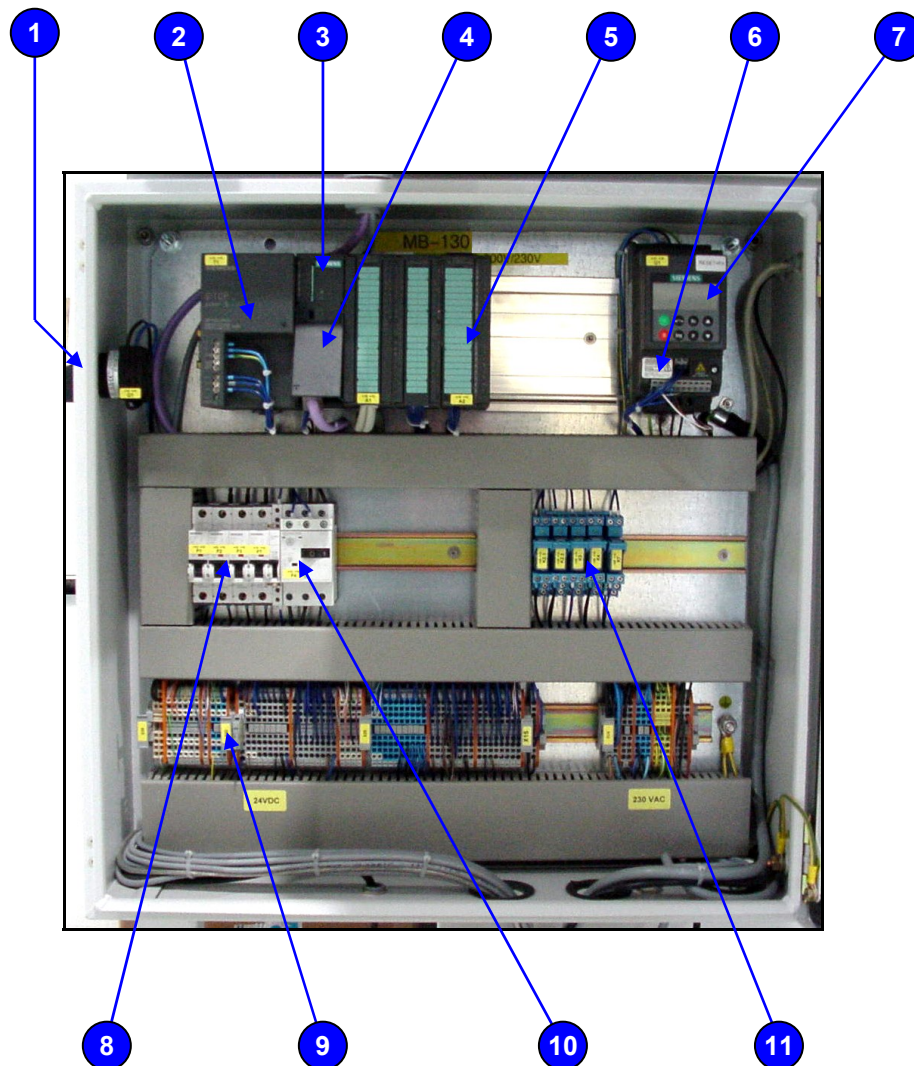

Workstation – Labmaster 130

Item Number	MBRAUN Number	Description
1	3240531	Fluorescent Tube
2		Gloves (see section 19.5 – Gloves)
3		Glove Port (see section 19.5 – Gloves)
4		O-Rings (see section 19.5 – Gloves)
5	9004513	Dust Filter (MB-BF-L-03)
6	3240052	Flow meter (type 2700)
7		Touch Screen (see section 22.1)
8	3240539	Exhaust Filter (EMF 20)
9	3240540	Gas Ballast Kit
10	3240487	Vacuum Pump (RV12)
11	5007021	Foot Pedal (GF2)

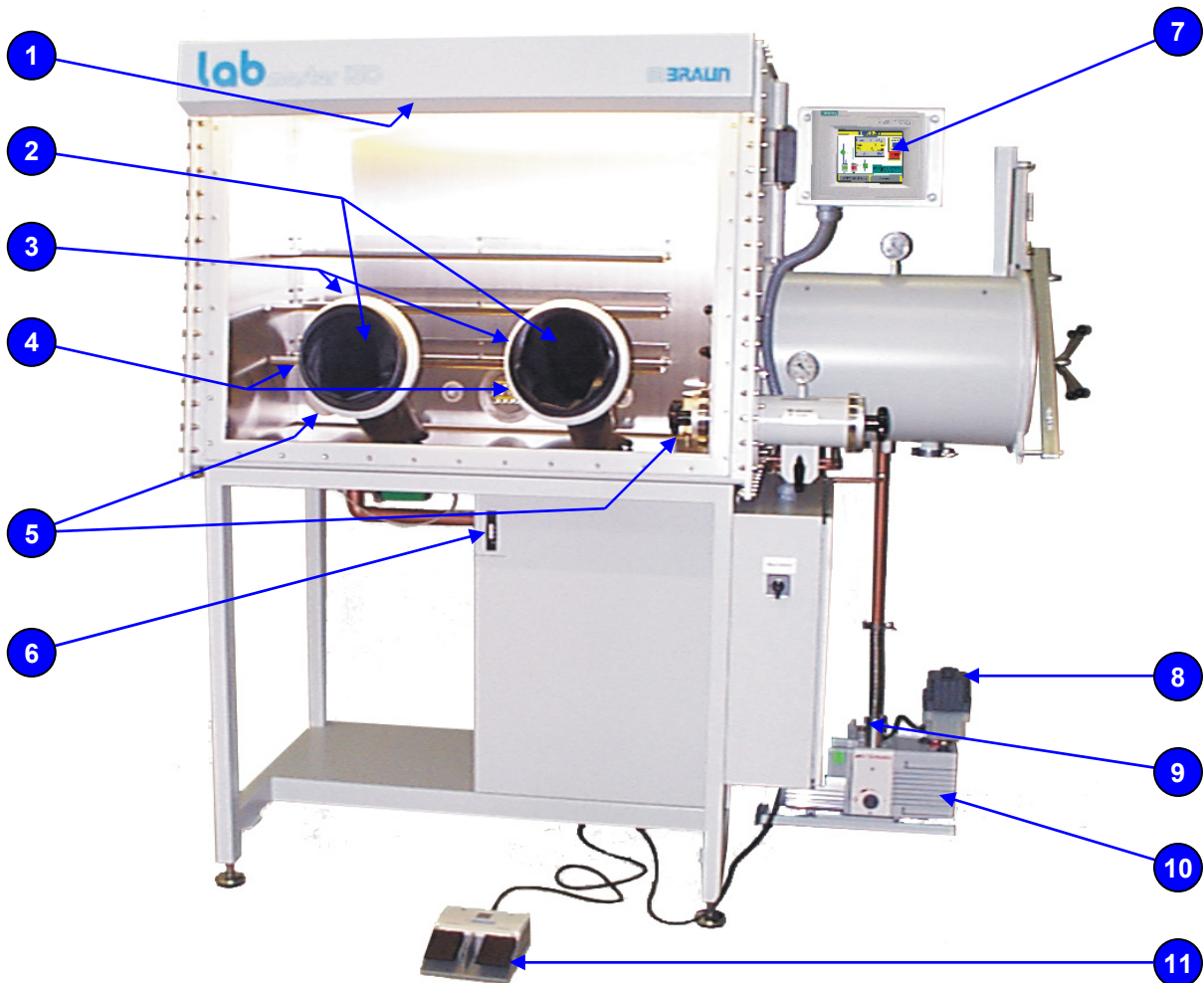

22.7. Gas Purification System – Labmaster 130

Item Number	MBRAUN Number	Description
1	9002725	Heat Exchanger
2	3210048	Valve Set (spool, core, spring)
3a	9002531-K	Electro-pneumatic Valve (MB-EPV 40 – Lacquered)
3b	9002533-K	Electro-pneumatic Valve (MB-EPV 40 – Nickel Plated)
4	3200069	Metal Tube (DN 40x500 – Flexible)
5	3200072	Metal Tube (DN 40x100 – Flexible)
6	6000301	Oxygen Sensor (MB-OX-SE1)
7	6000300	Moisture Sensor (MB-MO-SE1)
8a	3240139	Cu-Catalyst (4.5kg)
8b	3240262	Molecular-Sieve (5.5kg)
9	9002832	Blower (MB-BL-01)



22.8. Antechamber – Labmaster 130

Item Number	MBRAUN Number	Description
1	2405004	Manometer
2a	2400040	O-Ring for Mini-Antechamber Cover (Ø 100mm inlet/outlet)
2b	2400136	O-Ring for Mini-Antechamber Cover (Ø 150mm inlet/outlet)
3a	9002011	Mini-Antechamber Cover (Ø 100mm inlet/outlet)
3b	9002012	Mini-Antechamber Cover (Ø 150mm inlet/outlet)
4	2200480	Butterfly Valve (10mm MS)
5	3240327	Pneumatic Spring
6a	9005226	Antechamber Cover Complete (Left)
6b	9005225	Antechamber Cover Complete (Right)
7	7003674	Cover
8	3000016	Capstan Handle
9a	7003799	Antechamber Bar (Left)
9b	7003798	Antechamber Bar (Right)
10	2400309	O-Ring for Antechamber
11	3226006	Pirani Vacuum Sensor (TPR 256)
12	3210048	Valve Set (Spool, Coil, Spring)
13	4970007	Atmospheric Pressure Gauge
14	3220001	3/2-way Magnetic Valve (MFH-3-M5)
15a	9002531-K	Electro-pneumatic Valve (MB-EPV 40 – Lacquered)
15b	9002533-K	Electro-pneumatic Valve (MB-EPV 40 – Nickel Plated)

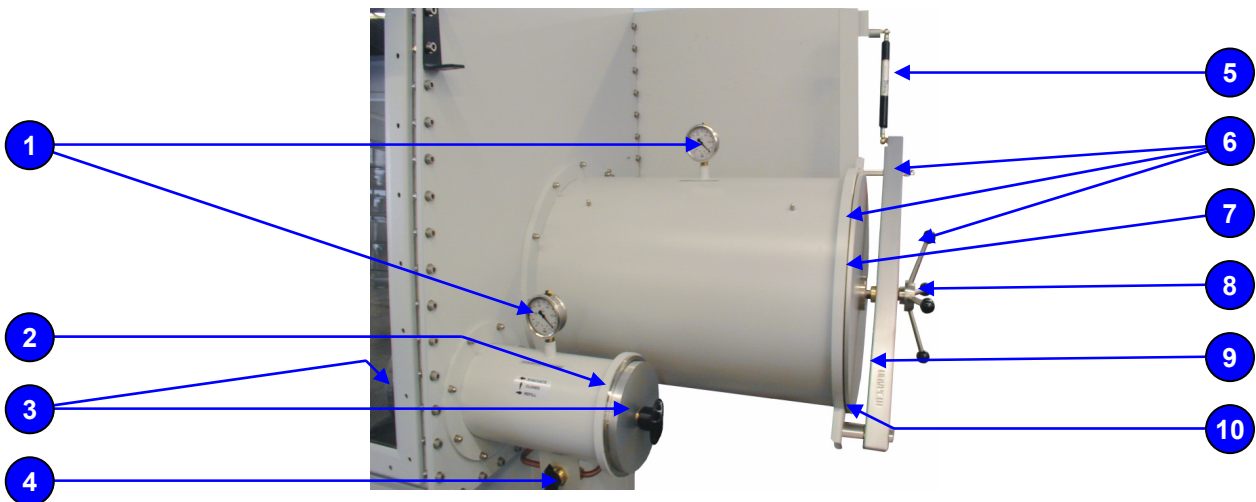

22.9. Solvent Filter (LMF)

Item Number	MBRAUN Number	Description
1	3203000	Metal Tube DN40KF (250mm)
2	2200480	3-Way Valve 10mm MS
3	9007091	Solvent Filter (LMF)
3a	2182000	Activated Charcoal (5.5kg)
4	9004501	Butterfly Valve (KF40 V2A)
5	3000072	Manometer

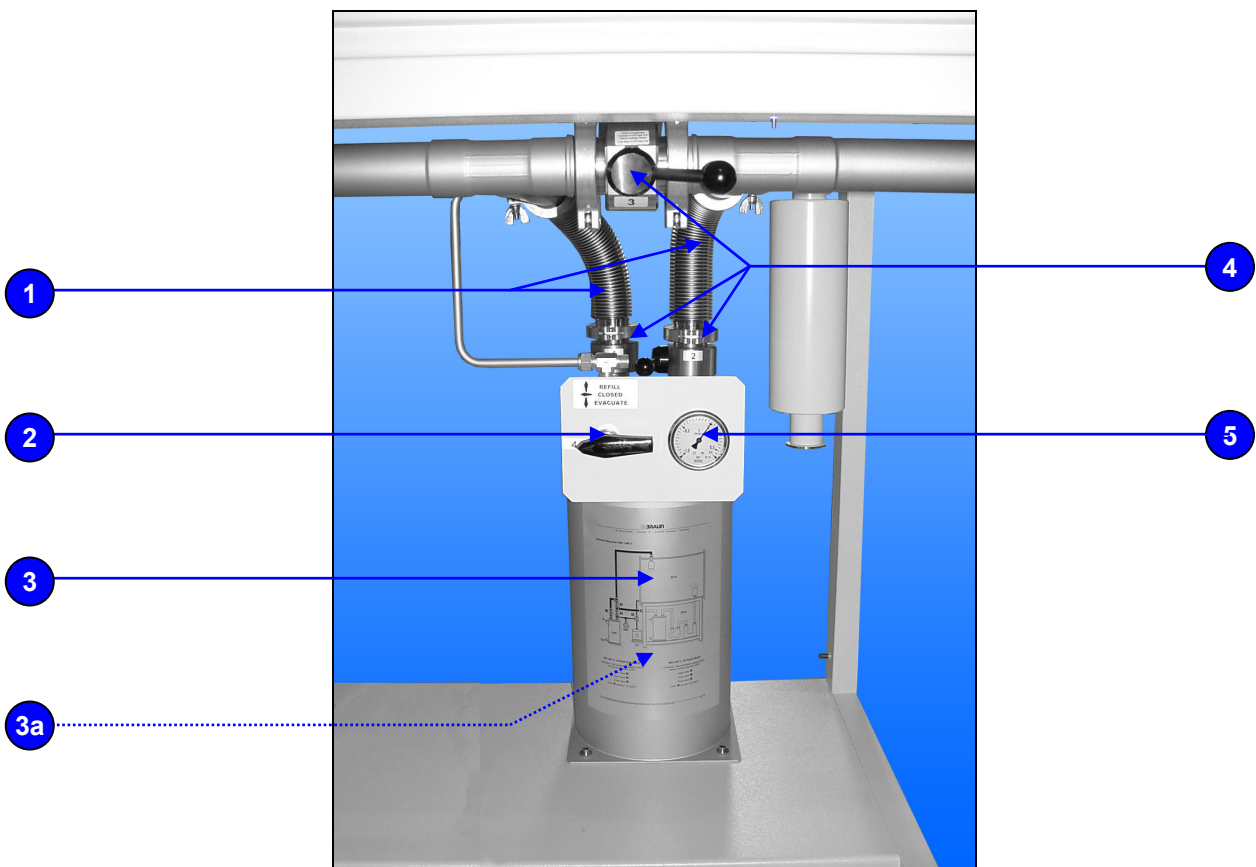

22.10. Analysers

Item Number	MBRAUN Number	Description
1	6000301	Oxygen Sensor – MO-OX-SE1 (0 – 1000 ppm O ₂)
2	6000302	Moisture Sensor – MO-MO-SE1 (0 – 500 ppm H ₂ O)



22.11. Vacuum Pump

Item Number	MBRAUN Number	Description
1	3240539	Gas Ballast kit for RV12 Pump
2	3240540	Oil Mist Filter
3	3240487	Vacuum Pump - RV12



Blank Page
